



Y50 Universal Instructions

Version: Ver.1.0

Statement

Dear user friend, thanks for choosing SSHENZHEN SYSOLUTION TECHNOLOGY CO.,LTD (hereinafter referred to as Xixun Technology) as your LED advertising equipment control system. The main purpose of this document is to help you quickly understand and use the product. We strive to be precise and reliable when writing the document, and the content may be modified or changed at any time without notice.

Copyright

The copyright of this document belongs to Xixun Technology. Without the written permission of our company, no unit or individual may copy or extract the content of this article in any form.

Trademark



is a registered trademark of Xixun Technology.

Update Record

No.	Version	Details	Date
1	Ver.1.0	Initial	2022.07.18

The document is subject to change without prior notice.

SHENZHEN SYSOLUTION TECHNOLOGY CO., LTD

Catalogue

Overview	1
Functions &Features	2
Interfaces	4
Technical Parameters	5
Hardware Connection Diagram	8
Software Operation Procedures	9
LedSet4.0 Basic Setting	10
Sending card configuration	10
Smart Setup	12
Receiver Card Setup	22
Screen Connection	29
LedOK Setup System Parameters	35
LED Screen Width And Height Pixels	35
LedOK Setup Network	36
Wire Setup	36
WiFi Configuration	36
3G/4G Setup	38
AIPS Cloud Platform Register	39
Register For AIPS Platform	39
AIPS Cloud Programing	41
Simple Program	41

Advanced Program43

Send Program 49

SHENZHEN SYSOLUTION TECHNOLOGY CO., LTD

Overview

Sysolution Y50 is a type of product that allows users to publish programs and control through PC, cell phone, Pad and other user terminals; it supports wireless transmission to eliminating wiring troubles, like a router for wireless network configuration; also supports accessing to the cloud platform, easy to achieve the cluster control remotely. The hardware and software design fully considers user deployment, operation, and maintenance scenarios, making deployment easier, operation more stable, and maintenance more efficient; with safe and stable function design, it saves space and reduces wiring for users, and can be used for car screen, small traffic screen, community screen, light pole screen and other small band load scenarios.

Y50 series adopts industrial-grade quad-core processor, integrating four Cortex-A35, dual-core Mali-G31 GPU, quad-core main frequency 1.5GHz, which can run stably under 90°C high temperature resistance, memory support 1GB+8GB (compatible with 2GB+16GB) LPDDR3. the chip can support GSM, WCDMA, TD-SCDMA, EVDO The chip can support GSM, WCDMA, TD-SCDMA, EVDO, TDD-LTE, FDD-LTE and other standards, and is a highly integrated product.

Functions &Features

1. Dual gigabit network port output, which can be used as backup all the way to ensure stable picture transmission.
2. Support external eight-element environment sensor R68 through 485 interface to display environment information without secondary development.
3. Support external Lora synchronization module to ensure synchronization of multi-screen screen playback.
4. support two remote power off, one way to control the screen switch and one way to control the street light switch.
5. support optional 4G module, different countries module models are different, shipping please provide the country of use.
6. Support FCC, CE certification.
7. Lora wireless time synchronization for multiple screens.
8. On-board WiFi module, to achieve wireless communication.
9. Support AP mode, Station mode.
10. support for secondary development, support for remote cluster control on the cloud platform.
11. Built-in Web Sever, support local web production, support PC, cell phone, Pad and other user terminals program release and display control, cluster remote program release and display control, cluster remote monitoring screen status.

12. Powerful processing performance, 4-core processor with 1.5GHz main frequency, supporting 1080P video hard decoding, 1GB running memory.
13. 16.8GB of internal storage space, 4GB available to users.
14. User terminal connects to Y50 WiFi hotspot, default SSID is "SN number", default password is "12345678".
15. Support GPS timing/time alignment.
16. Dual network ports with super loading capacity, resolution 1280*720.
17. Automatic adjustment of the display brightness, requiring a matching brightness sensor.
18. support for playing programs in accordance with the program list.
19. centralized setting of timer on/off, volume and brightness through management system.
20. Support for USB camera.
21. support for NTP accurate automatic time calibration.
22. Supporting software: AIPS4.0 cloud publishing platform, PC software LedOK Express, mobile APP: LedOK Kit.

Interfaces

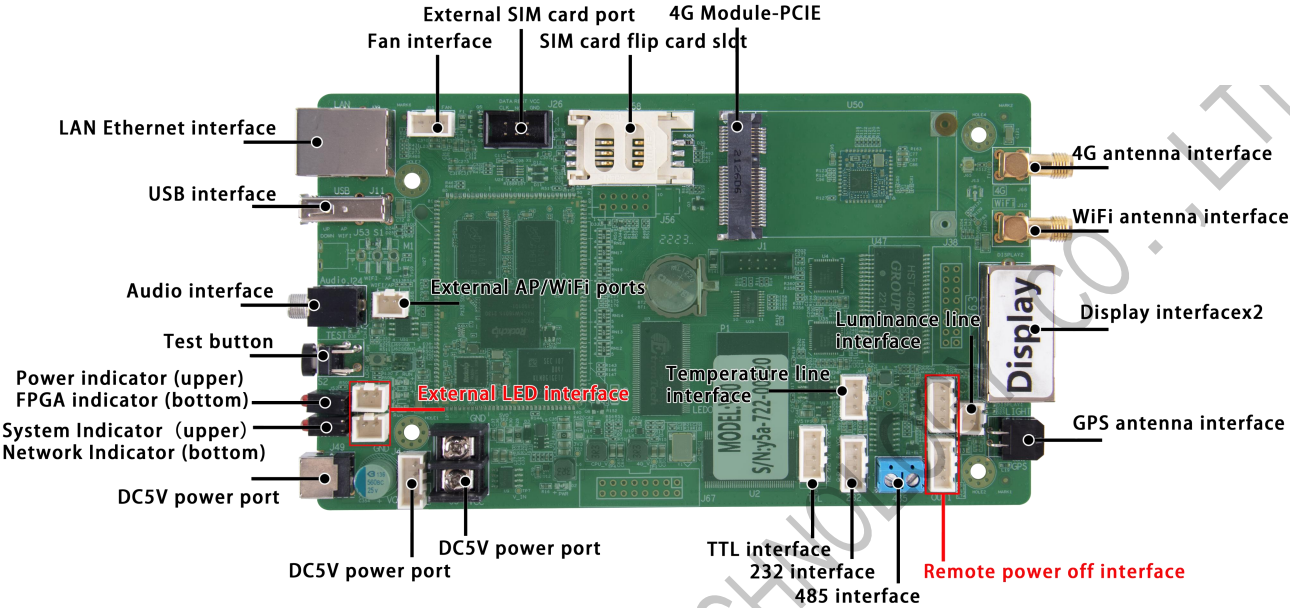

Y50 Interfaces

SHENZHEN SYSOLUTION TECHNOLOGY CO., LTD.

Technical Parameters

Features	Description	
Type	Y50-WIFI (no 4G) /Y50-NA、 Y50-EU、 Y50-LA、 Y50-G、 Y50-J	
Pixel	Y50: 920,000 pixels, resolution 1280 (w) *720 (h)	
Communication mode	Ethernet port、 WiFi、 USB	
CPU	Cortex-A35 4 core main frequency1.5GHz	
GPU	Mali-G31MP2 OpenGL ES3.2, Vulkan 1.0, OpenCL 2.0 Dvalin-2EE	
System memory	8GB Emmc+1GB LPDDR3	
Operating system	Android 9	
WiFi	IEEE 802.11b/g/n 2.4G	
GPS	GNSS GPS/Beidou/Glonass	
Other interface support	<ol style="list-style-type: none"> 1. 1 channel stereo audio output 2. 1 USB2.0 port 3. Support play program through USB 4. 1 RS485 port, 1 RS232、 1 TTL serial port. Connect to light sensor or other sensors, as well as connecting to other modems to realize other functions. 	
Configuration software	LedOK Express	
Support frequency band		
Type	3G/4G (optional)	Certificate

<p>Y50-CH</p>	<p>-China (China/India)</p> <p>FDD-LTE: B1/3/5/8</p> <p>TDD-LTE: B38/39/40/41</p> <p>TDSCDMA: B34/39</p> <p>WCDMA: B1/8</p> <p>CDMA 1X/EVDO: BC0</p> <p>GSM: B3/5/8</p>	<p>Compulsory Certification : SRRC/ NAL/ CCC</p> <p>Others : WHQL</p>
<p>Y50-NA</p>	<p>-North America</p> <p>FDD-LTE: B2/4/5/7/12/13/17</p> <p>WCDMA: B2/4/5</p>	<p>Operator certification: AT&T/ T-Mobile/Rogers/ TelusVerizon/AT&T (FirstNet)/T-Mobile/U.S.</p> <p>Cellular/Rogers/ Telus</p> <p>Mandatory / conformance certification: FCC/ IC/ PTCRB</p> <p>Others : WHQL</p>
<p>Y50-EU</p>	<p>-Eurasia</p> <p>(EMEA/Korea/Thailand/India and other Asian countries)</p> <p>FDD-LTE: B1/3/5/7/8/20</p> <p>TDD-LTE: B38/40/41</p> <p>WCDMA: B1/5/8</p> <p>GSM: B3/5/8</p>	<p>Operator certification:</p> <p>Vodafone/Deutsche Telekom/SKT/ Telefónica</p> <p>Mandatory / conformance certification: GCF/ CE/ KC/ NCC/RCM/ FAC/ NBTC/ICASA</p> <p>Others : WHQL</p>

<p>Y50-LA</p>	<p>-Latin America (LA/AU/Newslan)</p> <p>FDD-LTE: B1/3/5/7/8/28</p> <p>TDD-LTE: B40</p> <p>WCDMA: B1/2/5/8</p> <p>GSM: B2/3/5/8</p>	<p>Compulsory Certification: GCF/ FCC/ Anatel/ NCC/RCM</p> <p>Others: WHQL</p>
<p>Y50-G</p>	<p>-Global</p> <p>FDD-LTE: B1/2/3/4/5/7/8/12/13/ 18/19/20/25/26/28</p> <p>TDD-LTE: B38/39/40/41</p> <p>WCDMA: B1/2/4/5/8/6/19</p> <p>GSM: 4 frequencies</p>	<p>Operator certification: Deutsche Telekom/ Verizon/ AT&T/ Sprint/U.S. Cellular/ Telus</p> <p>Mandatory / conformance certification: GCF/ CE/ FCC/ PTCRB/ IC/ Anatel/IFETEL/ SRRC/ NAL/ CCC/ KC/ NCC/ JATE/ TELEC/ RCM/ NBTC/ IMDA/ICASA</p> <p>others: WHQL</p>
<p>Y50-J</p>	<p>-Japan</p> <p>FDD-LTE: B1/3/8/18/19/26</p> <p>TDD-LTE: B41</p> <p>WCDMA: B1/6/8/19</p>	<p>Operator certification: NTT DOCOMO/SoftBank/ KDDI</p> <p>Compulsory Certification: JATE/ TELEC</p> <p>Others : WHQL</p>

Hardware Connection Diagram

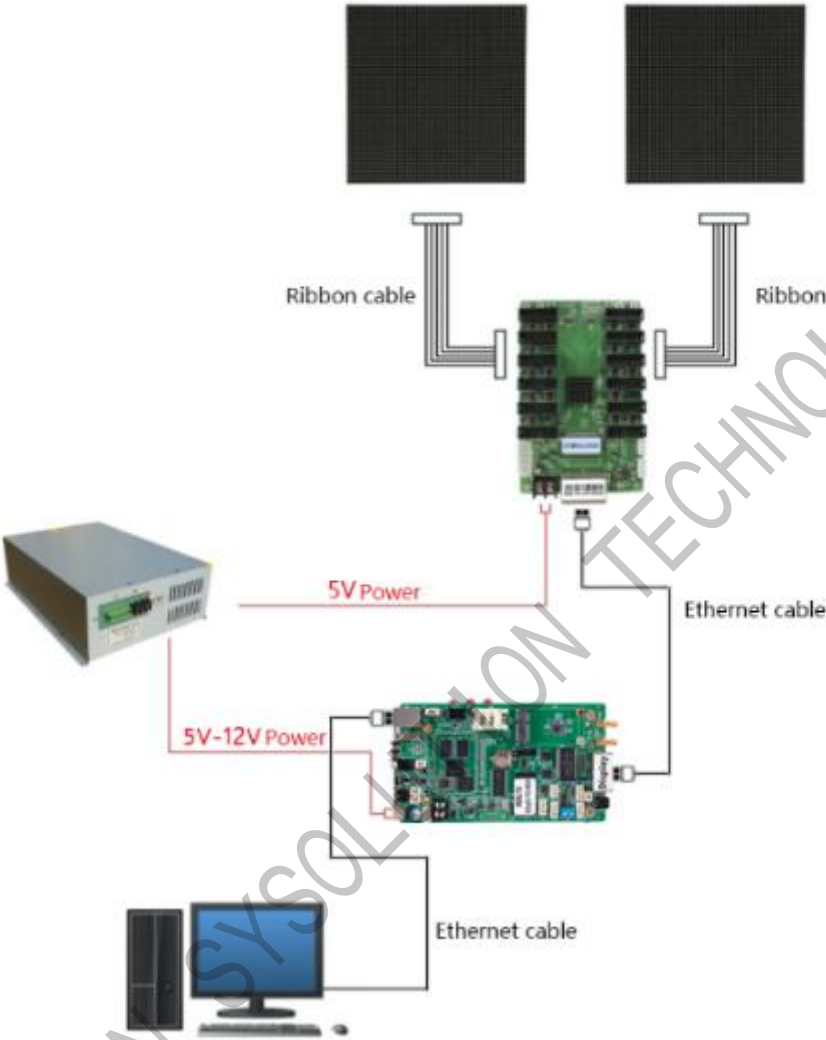

Software Operation Procedures

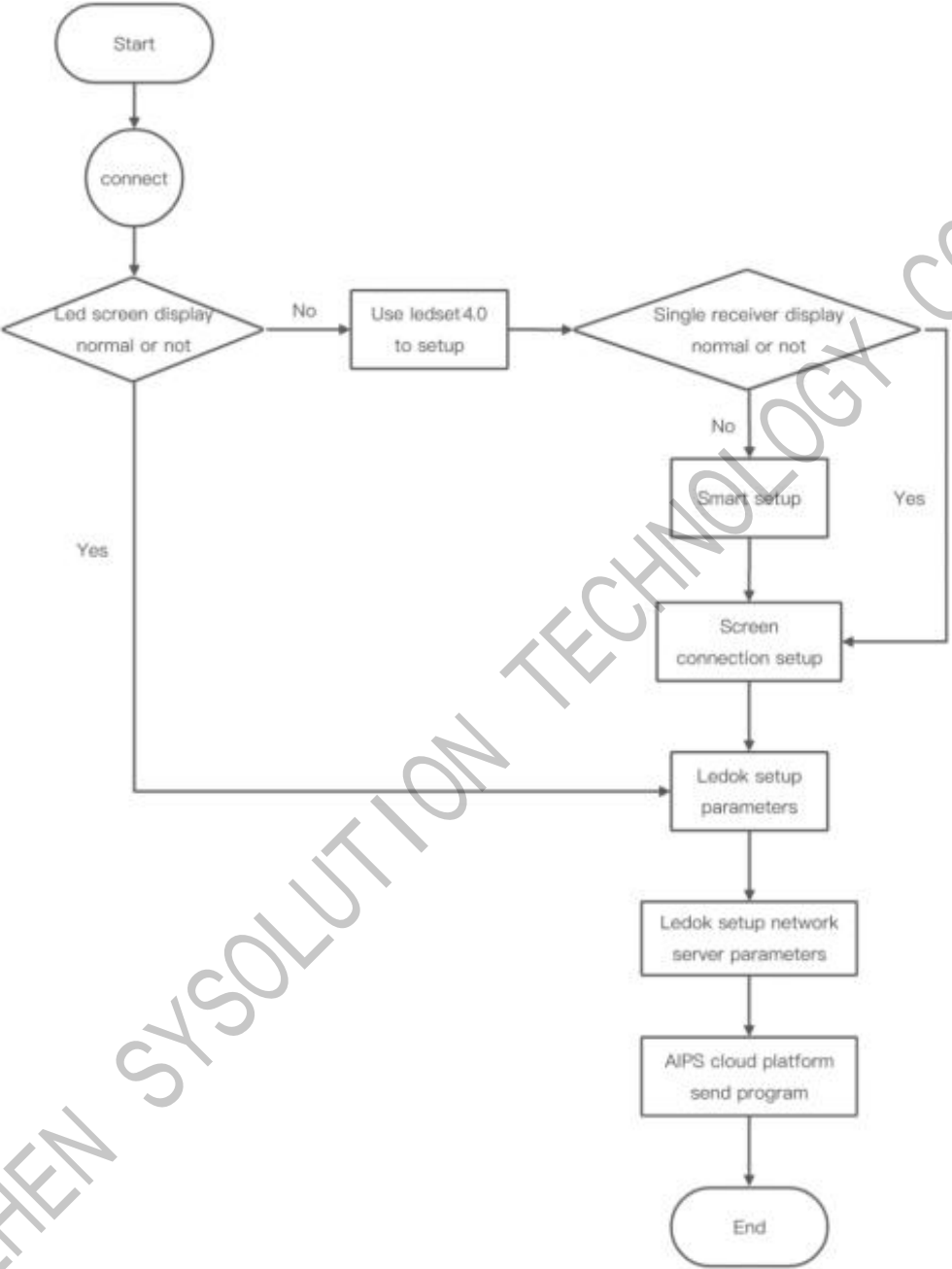

SHENZHEN SYSOLUTION TECHNOLOGY CO., LTD

LedSet4.0 Basic Setting

Sending card configuration

1. Confirm the hardware connection, open LedOK Express software, in the device management interface can automatically detect the transmitter card, can not detect the transmitter card, please click the refresh button on the right side of the software interface. If it is connected through the network cable, please open the bottom left corner of the software interface of the network cable direct connection button, click a key repair can be.

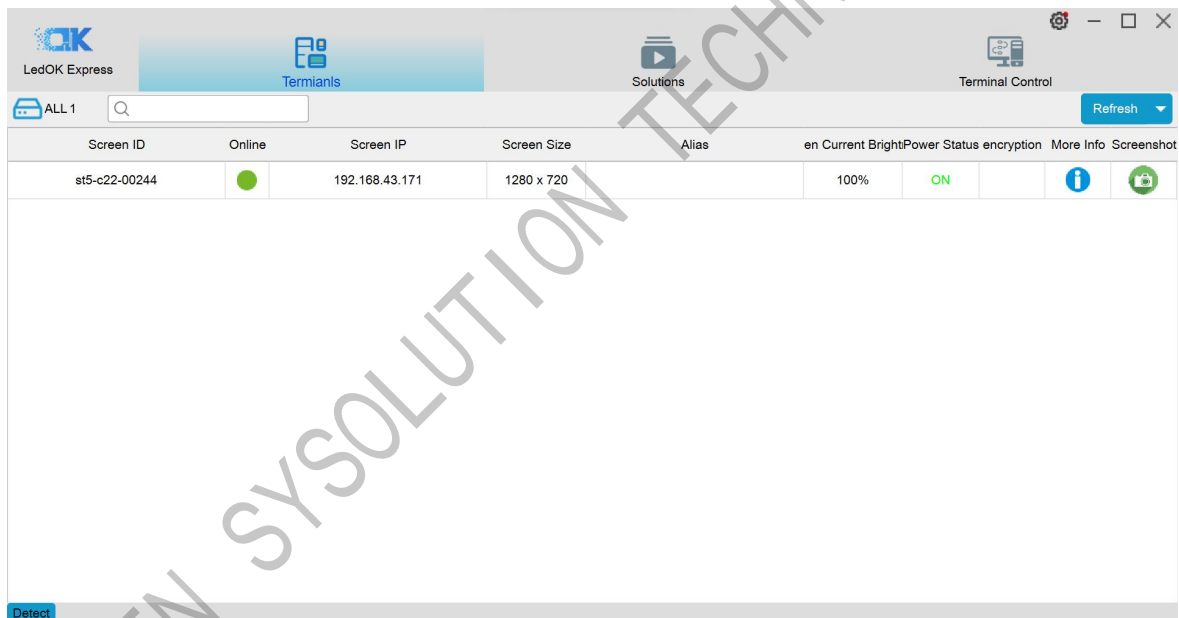

2. Then click Terminal Control, select Control Card, open Advanced Settings, and enter the password (888) to enter the Advanced Settings screen.

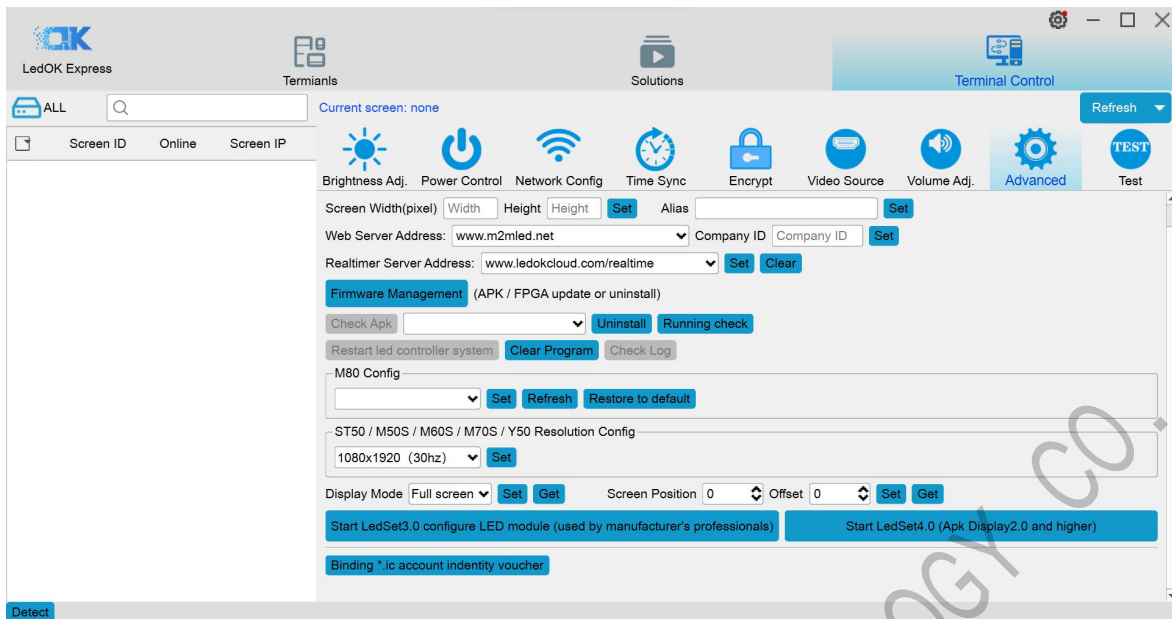

3. Click Use LedSet4.0 to configure the LED module at the bottom of the Advanced Settings screen to open the LedSet4.0 software interface.

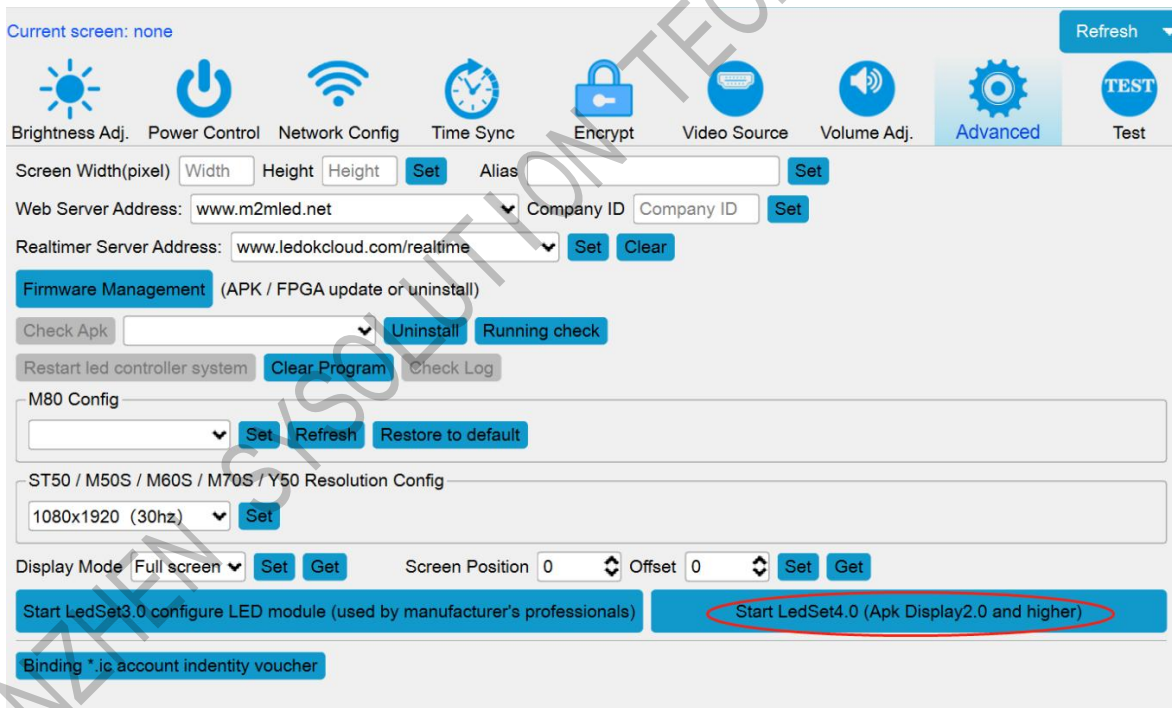

4. In the LedSet 4.0 interface, open the transmitter card and make sure that the transmitter and receiver cards are connected properly and communication is established with the software.



Note: LedSet3.0 cannot detect the sending card, please close the firewall and other anti-virus software.

Smart Setup

5. Choose Normal mode debug.

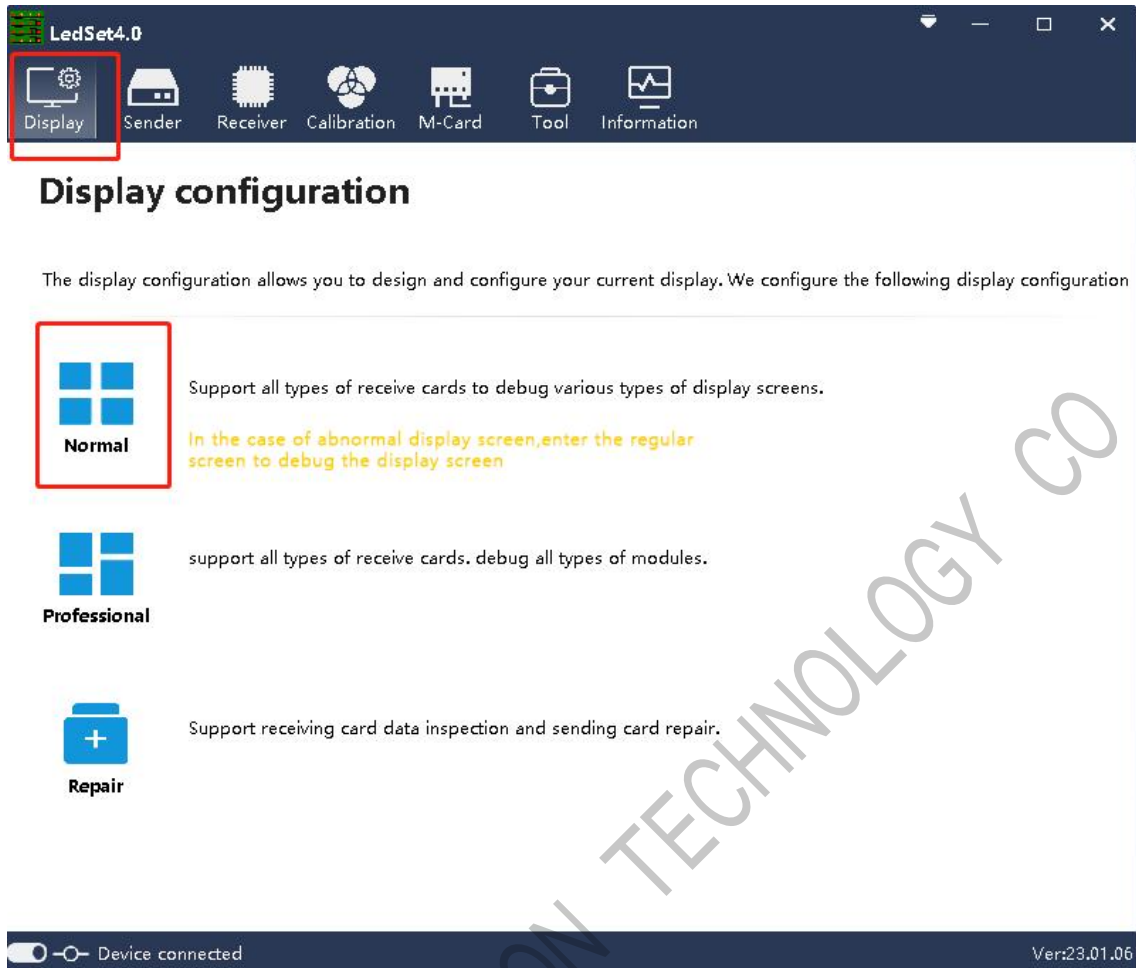

6. Choose Smart setup wizard and start configuration.

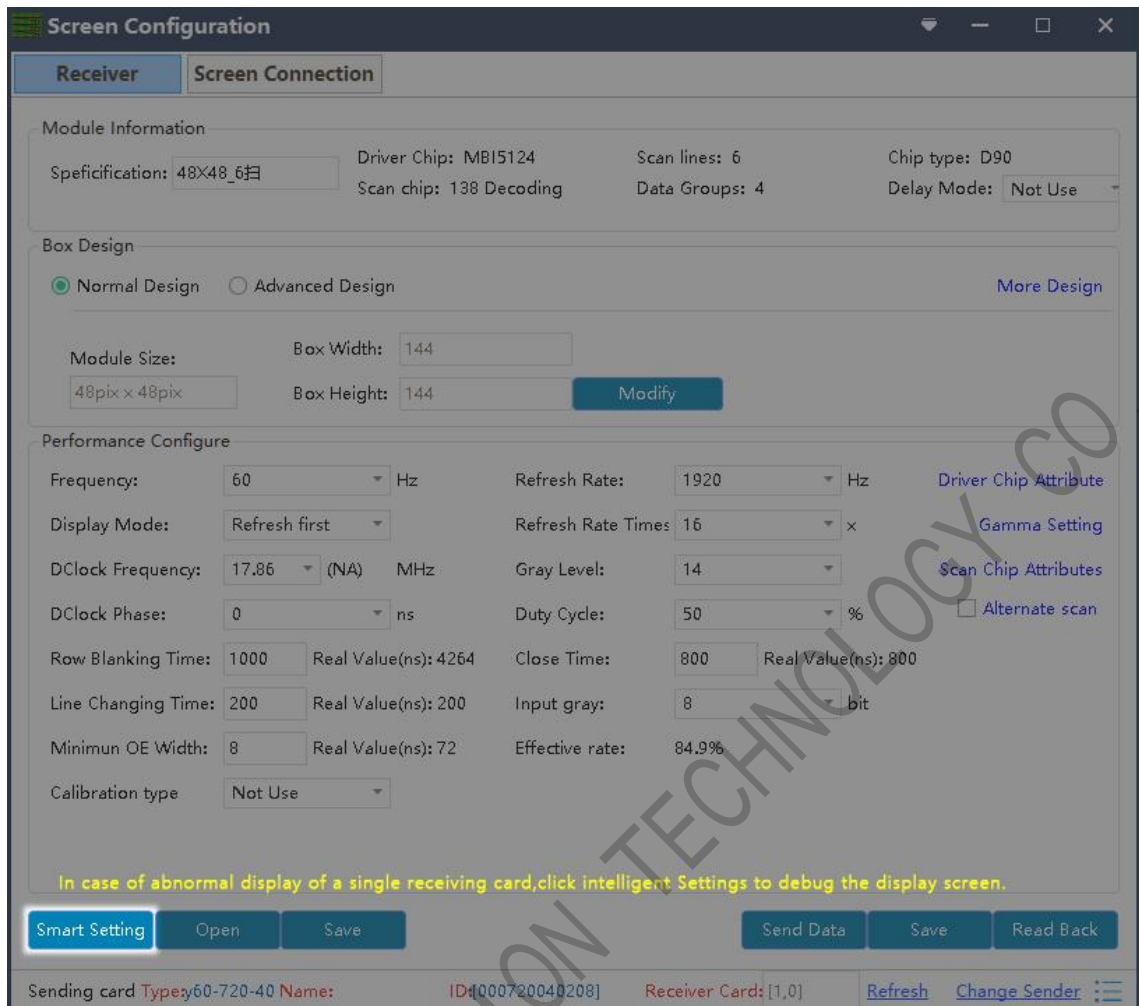

7. Please enter the correct parameters to the smart setup dialogue box .

① **Module width/height:** input the actual pixel of the current pixel.

② **Module data group:** view the interface definition of module data input port and calculate according to the actual data line number and grouping mode of module.(Generally, three lines are parallel, so an RGB is a set of data. For example, if a module has two sets of RGB, then the module data group is 2).

③ **Card type:** type of receiving card currently used for debugging which can directly view according to the identity on the receiving card.

④ **Blanking polarity:** low/high effective, normally use the default one.

⑤ **Contrl system:** please choose T6(D90 series) or FPGA(D80 series) according to your receiver card types

⑥ **Drive chip:** select the type of drive chip used in the current module, such as: conventional chip, MBI5153, ICN2053, etc.

⑦ **Decoding method:** "138 decoding", "5958 decoding", "high direct output", etc.

⑧ **Grouping mode:** Viewing the interface definition of the current module data input port, if having R/G/B three colors (red, green and blue) signal data (red, green, and blue lights on driver chip is separate connection, and no string between them, thus choose "parallel three line" ;if there is only one color signal data on the module or only one R data (In addition to the single color screen, and the chip controlling the red, green and blue LED lights is connected together), then select "RGB serial" .

⑨ **Double clock:** No need to choose when configure normal module. Only need to choose D, E, F signal for second clock when configure double clock led module.

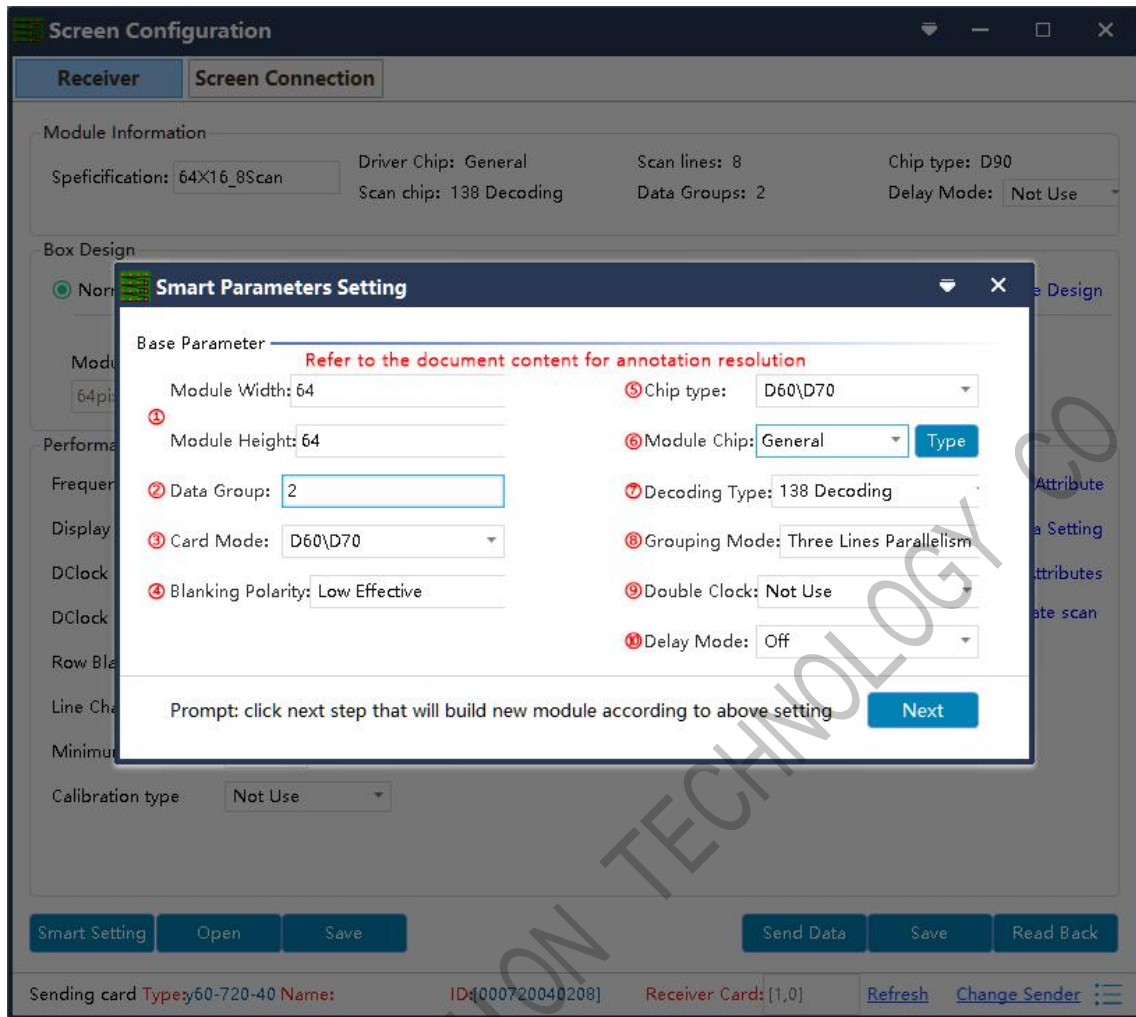

8. Click Next step and enter choose of Data polarity, please choose correct according to screen changes.

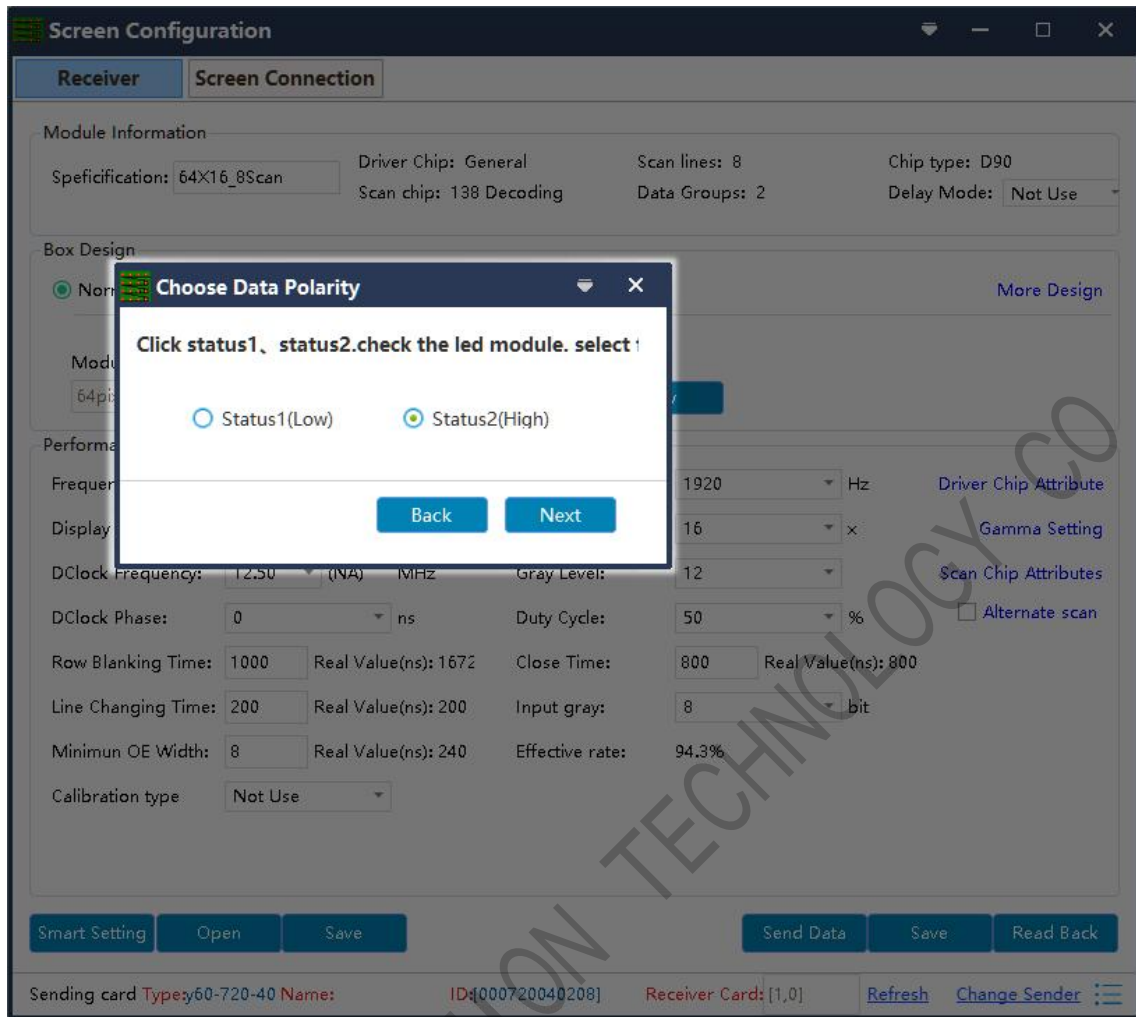

9. Click "Next Step" to enter the "OE polarity selection window". Select the corresponding state according to the actual display of the current module.

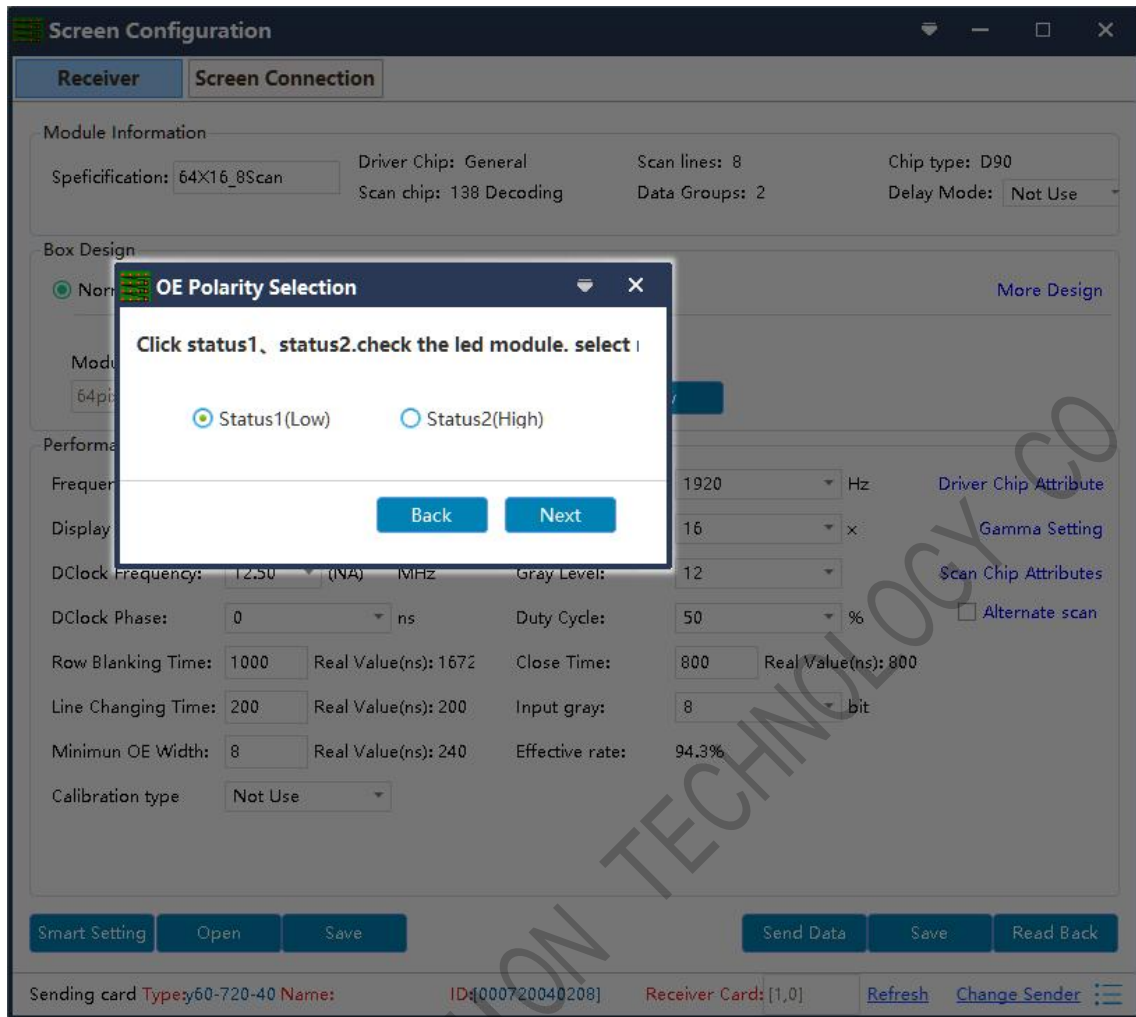

10. Click "Next Step" to enter the "scan line number" window and select the scan line according to the actual display of the current module.

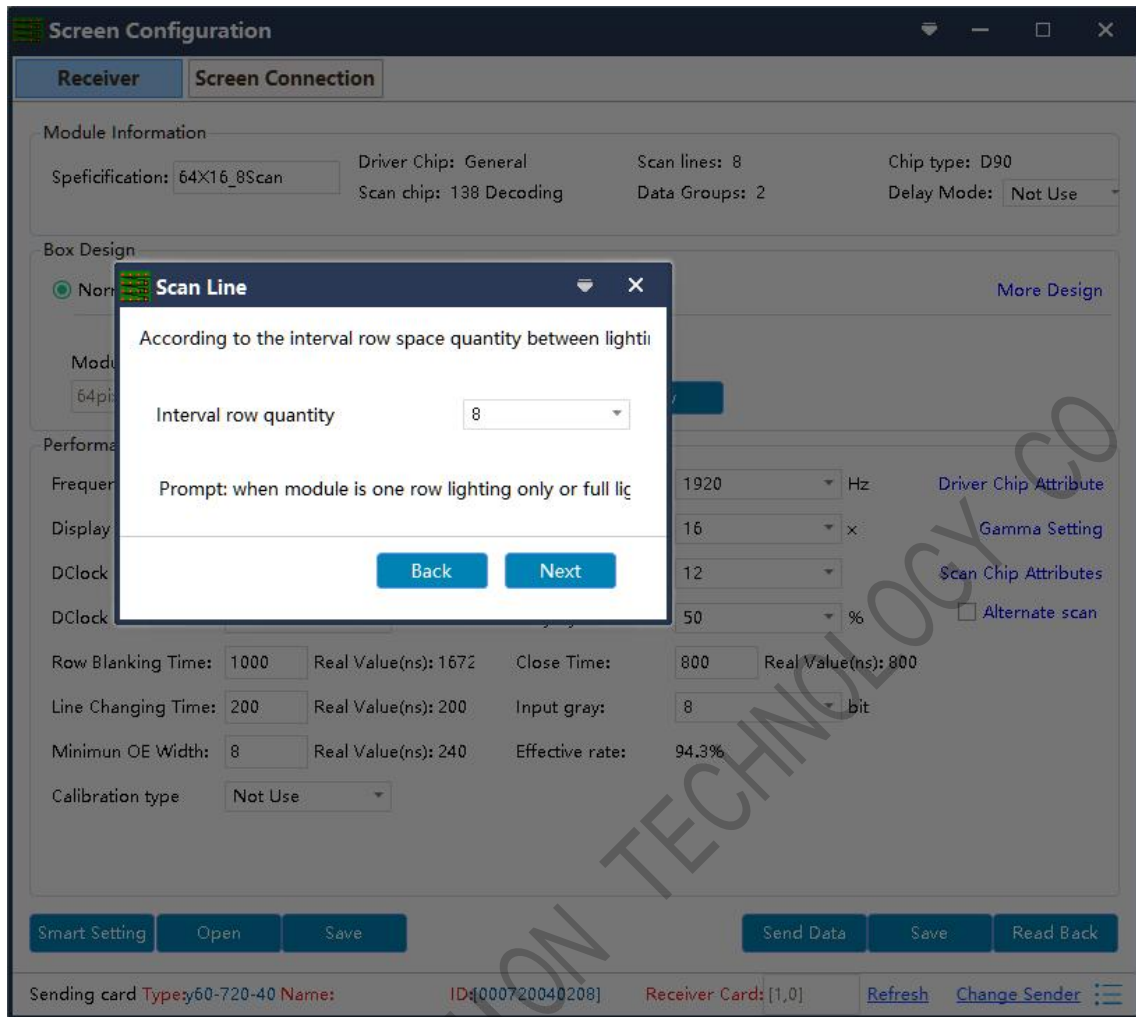

11. Click "Next Step" to enter the select color window. Select the corresponding display color according to the state mode.

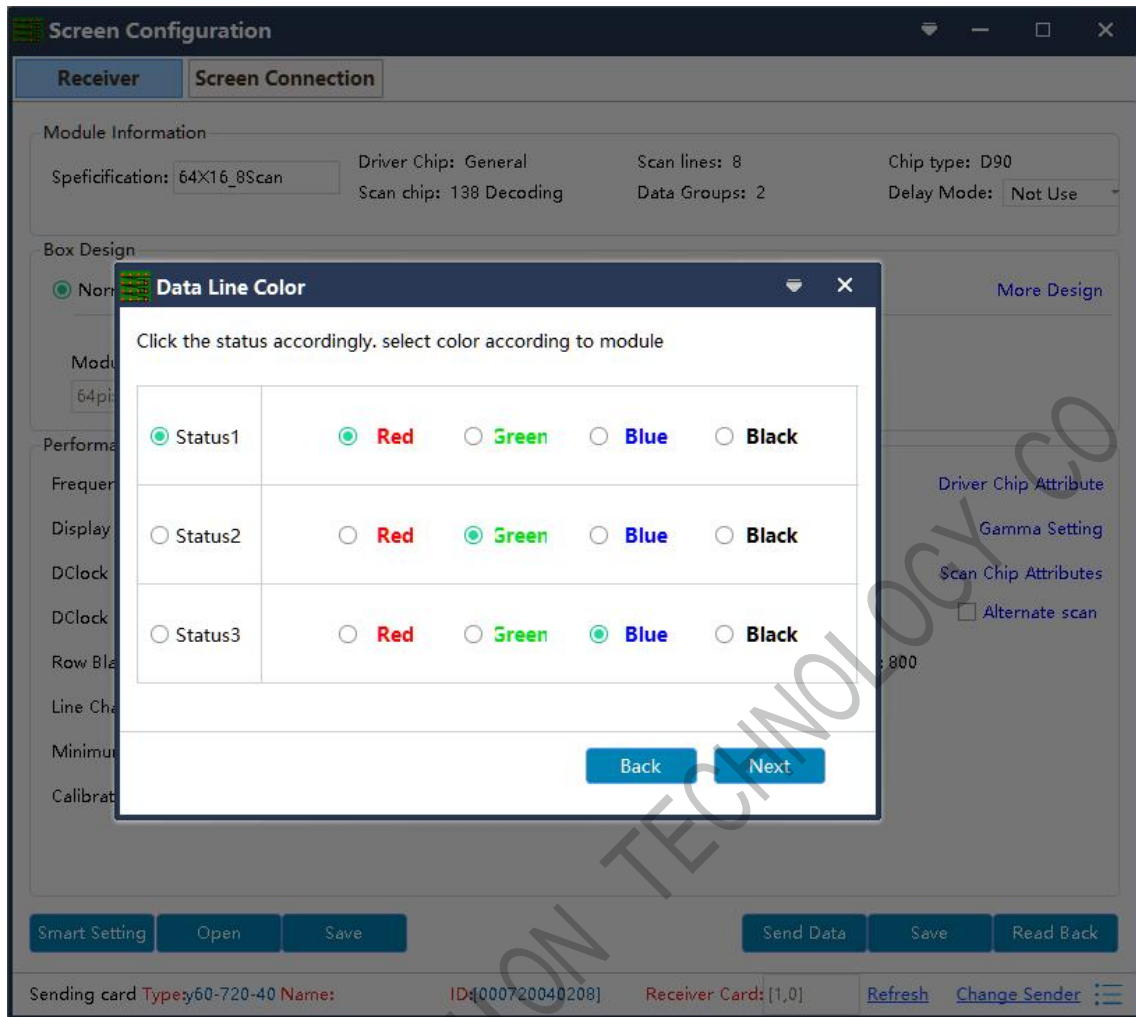

12. Click "Next step" to enter the "intelligent Settings" window and do the walk-points according to the actual display of the module.

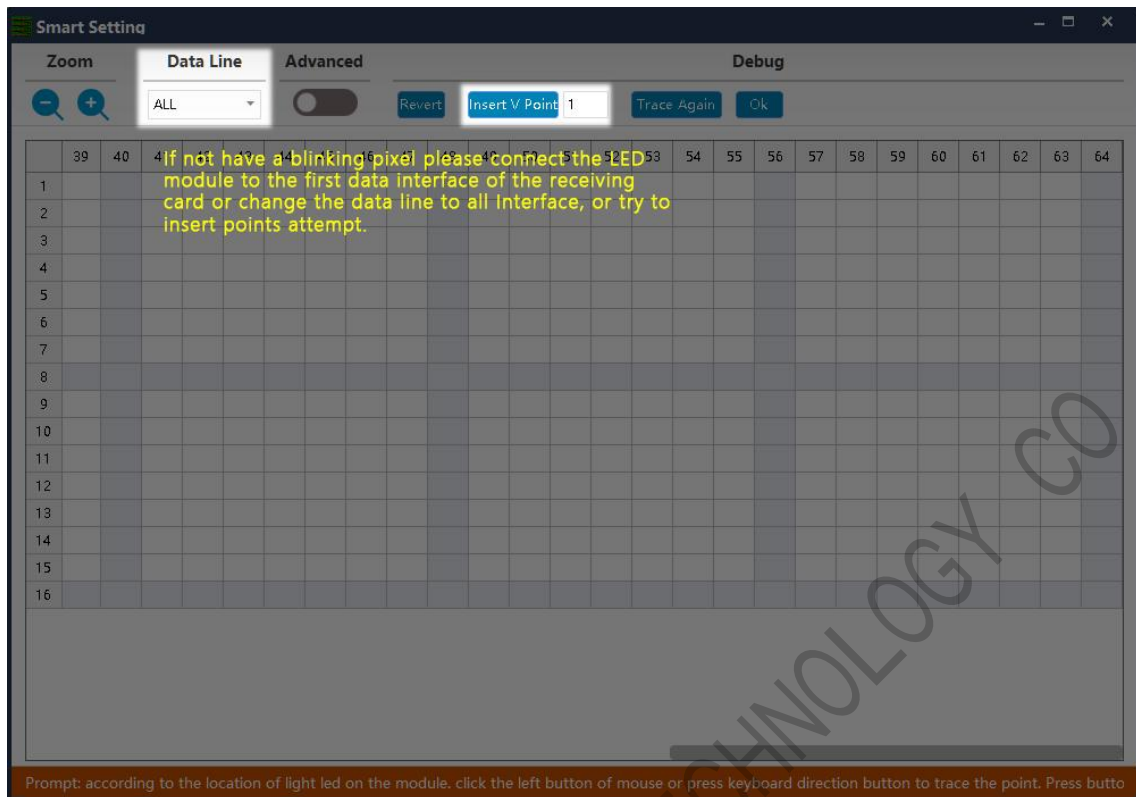

13. Click Complete to finish the smart setup.

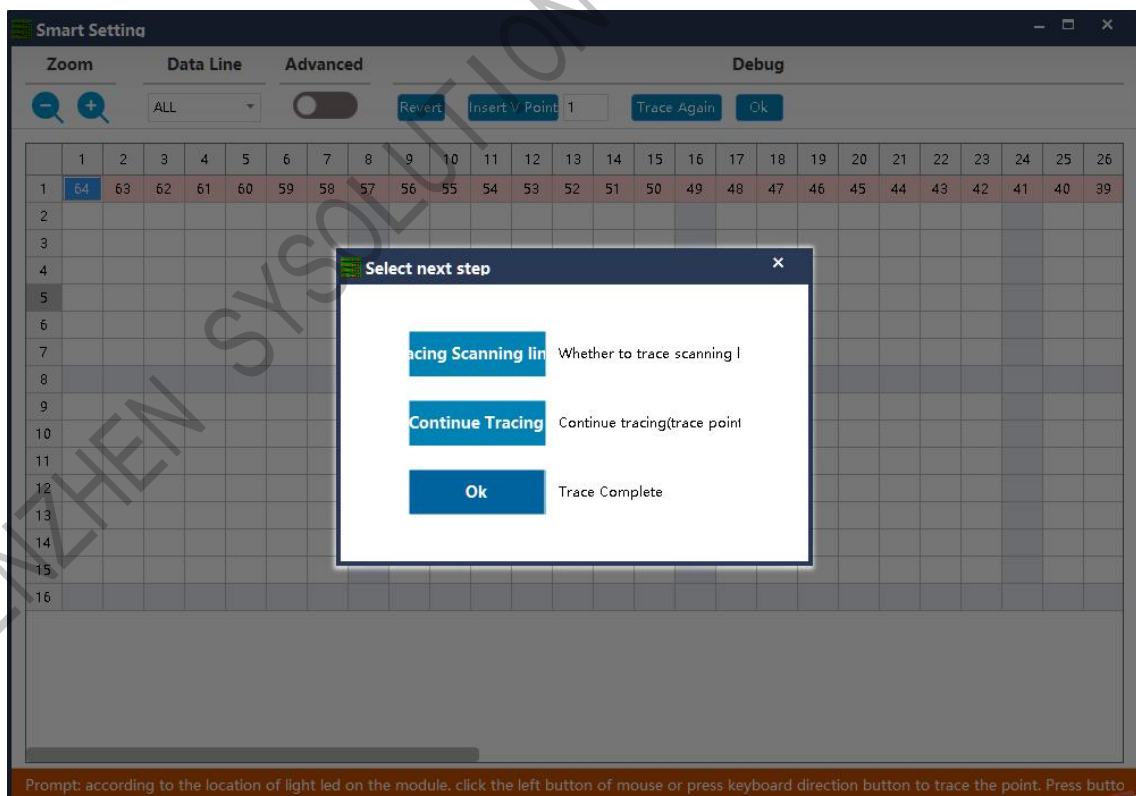

14. Click finish.

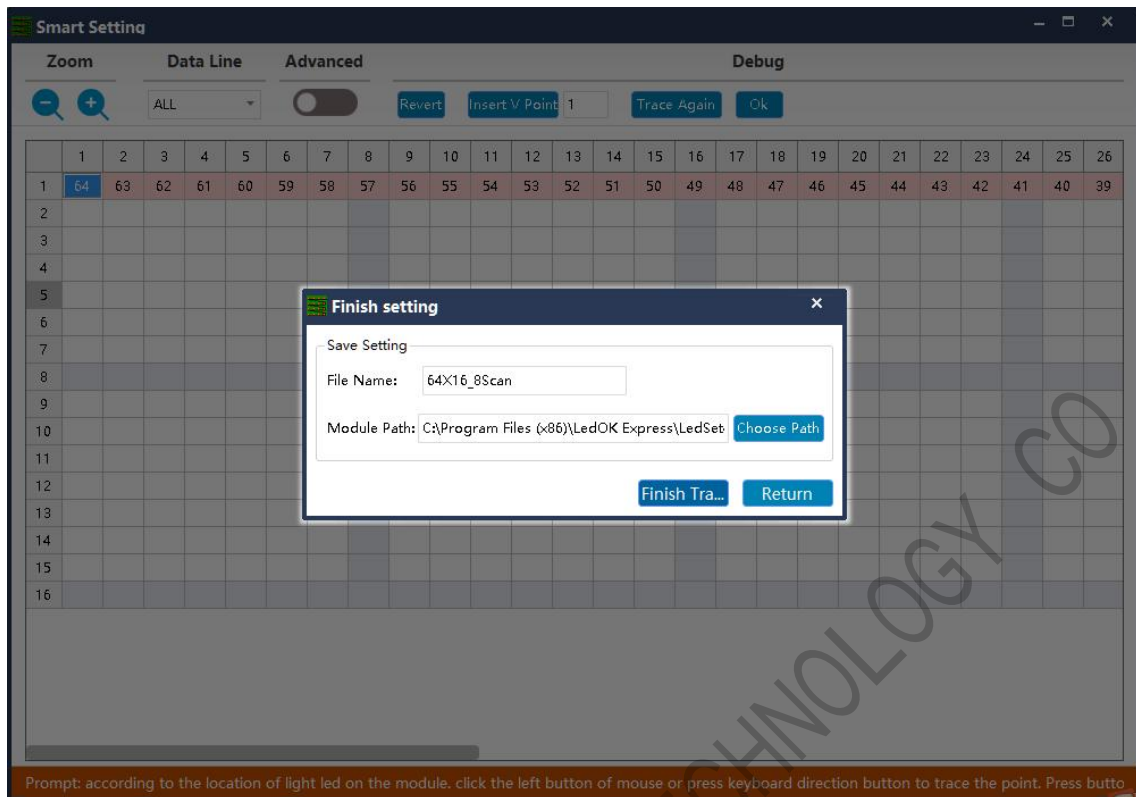

Receiver Card Setup

15. It can be configured by means of "smart setting" or by default "option modules" (applicable to receiving cards D90-75) to load module file or by "open box file" after loading preservation cabinet file.

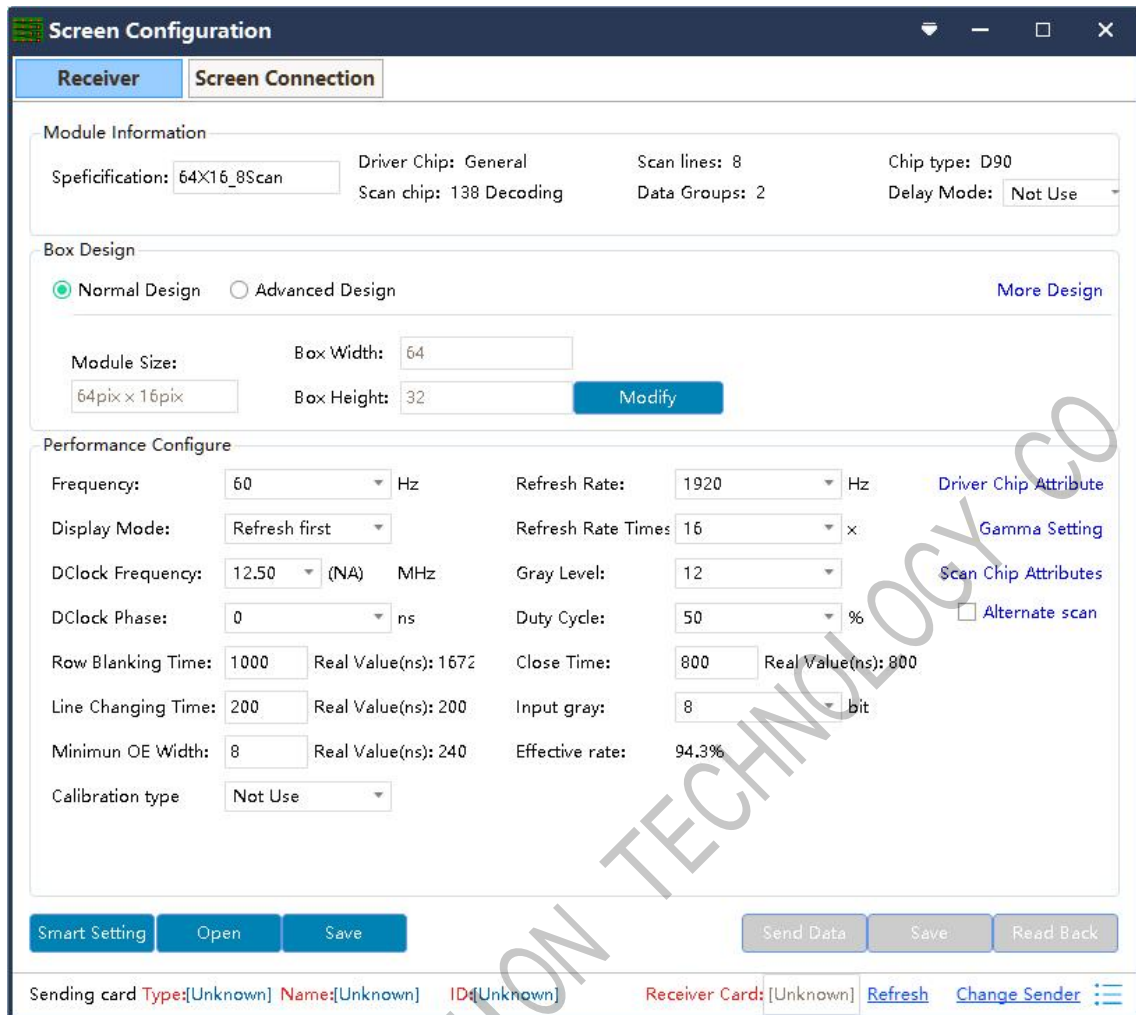

16. Box Design, choose Normal design and click Modify , then enter the box width and height pixels according to your cabinet and choose the correct cascading direction and click complete.

① **Output mode:** with symmetrical to quadruple strip outputs, It can give full play of the receiving card performance to make the screen higher refresh rate according to actual needs. For example(cascade way: from right to left).

② **Normal output:** 1 to 24 sets of data are loaded from top to bottom.

③ **Symmetrical:** The data of the receiving card (1-12) group is equipped with the left half lamp board, and the data of (12-24) group is equipped with the right half lamp

board, with the same width/height.

- ④ **Triple strip mode:** 1-8, 9-16, 17-24, Each 8 sets of data are carried in three parts

horizontally with the same width and height

- ⑤ **Quadruple strip:** 1-6, 7-12, 13-18, 18-24, Each 6 sets of data are carried in four

parts horizontally with the same width and height.

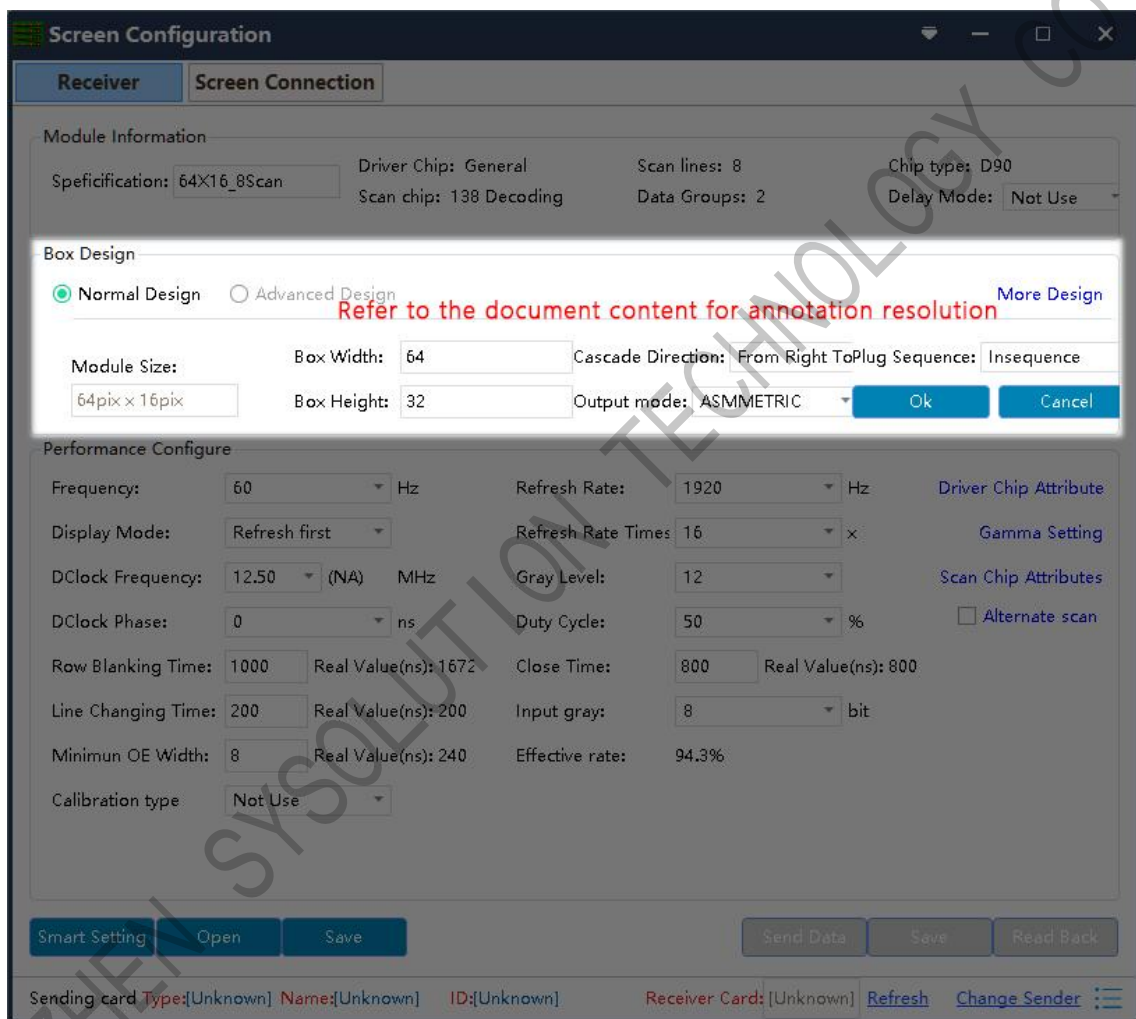

17. The System will auto calculate the performance configuration parameters after done box design, you can also adjust some options to make display effect better.

Refresh rate: an important indicator of the Led screen. Increasing the refresh frequency can improve the water ripple when using the camera to take pictures.

Display mode : It can be divided into refresh priority and Grayscale priority.

Refresh priority: In this mode, the brightness efficiency will be reduced while the refresh rate of the module can be greatly improved. **Grayscale priority:** This mode will have a better grayscale effect at low brightness.

Refresh rate times: High brush algorithm for improving visual refresh rate, default 16.

Data clock frequency: it is related to the design of LED module circuit and the driving chip used. If the well-designed high brush IC is used, the module can be reached higher clock while gray degree and refresh frequency can be supported higher with the same load area.

Grayscale: Increasing the grayscale according to the requirements of the LED. The higher the grayscale, the better the picture quality. Generally, it is 12 to 14bit, (12bit grayscale is equal to 4096 gradation grayscale)

Data clock phase: timing starting point of the clock setting. It can be adjusted when the screen body has flash point, flower screen and other abnormal phenomena. Generally 12.5~17.86.

Duty cycle: refers to the duty cycle of the clock phase. Changing this data can make the scanning clock phase higher generally set to 50%.

Line changing time/discharge time/sweeping position: mainly adjust the scan screen afterglow, the newline value time can be increased if serious, generally take the default values.

Min OE width : Min response time. When the refresh cannot be improved

effectively, try to reduce it.

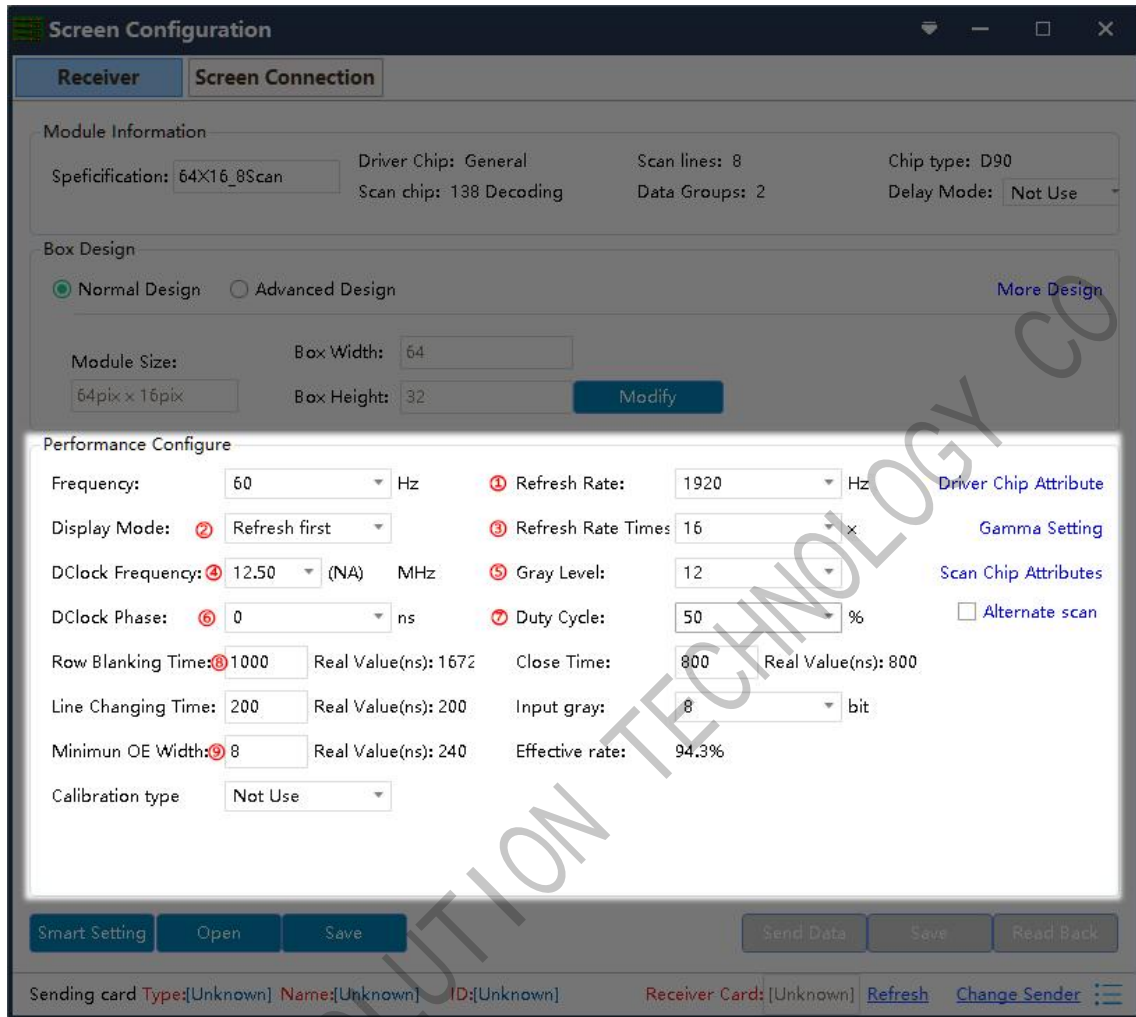

18. Click the " send data" button to send the program to the receiving card.

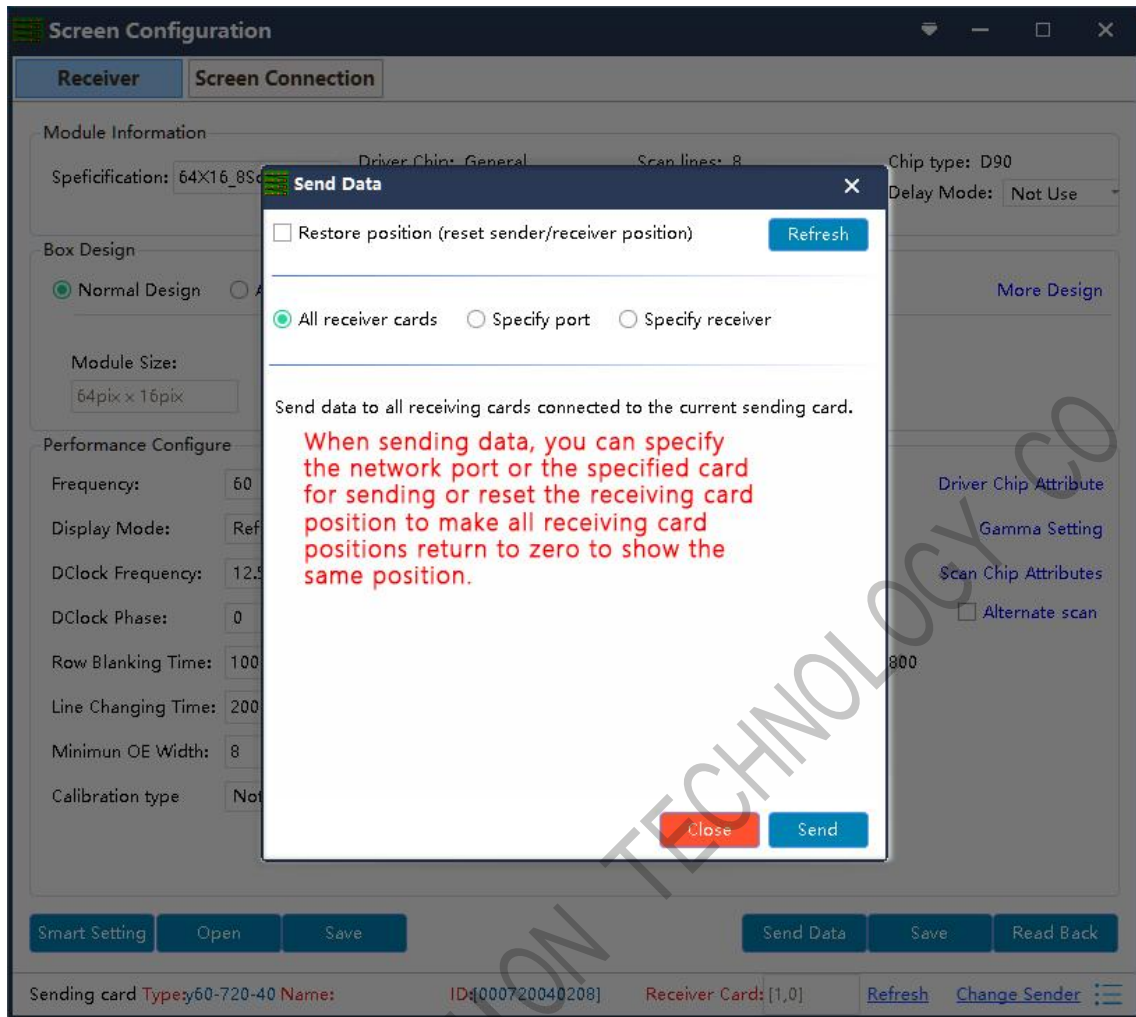

19. Observe whether the box is displayed normally. Then click the "save" button and solidify the data to the receiving card to prevent data loss from power off and restarting.

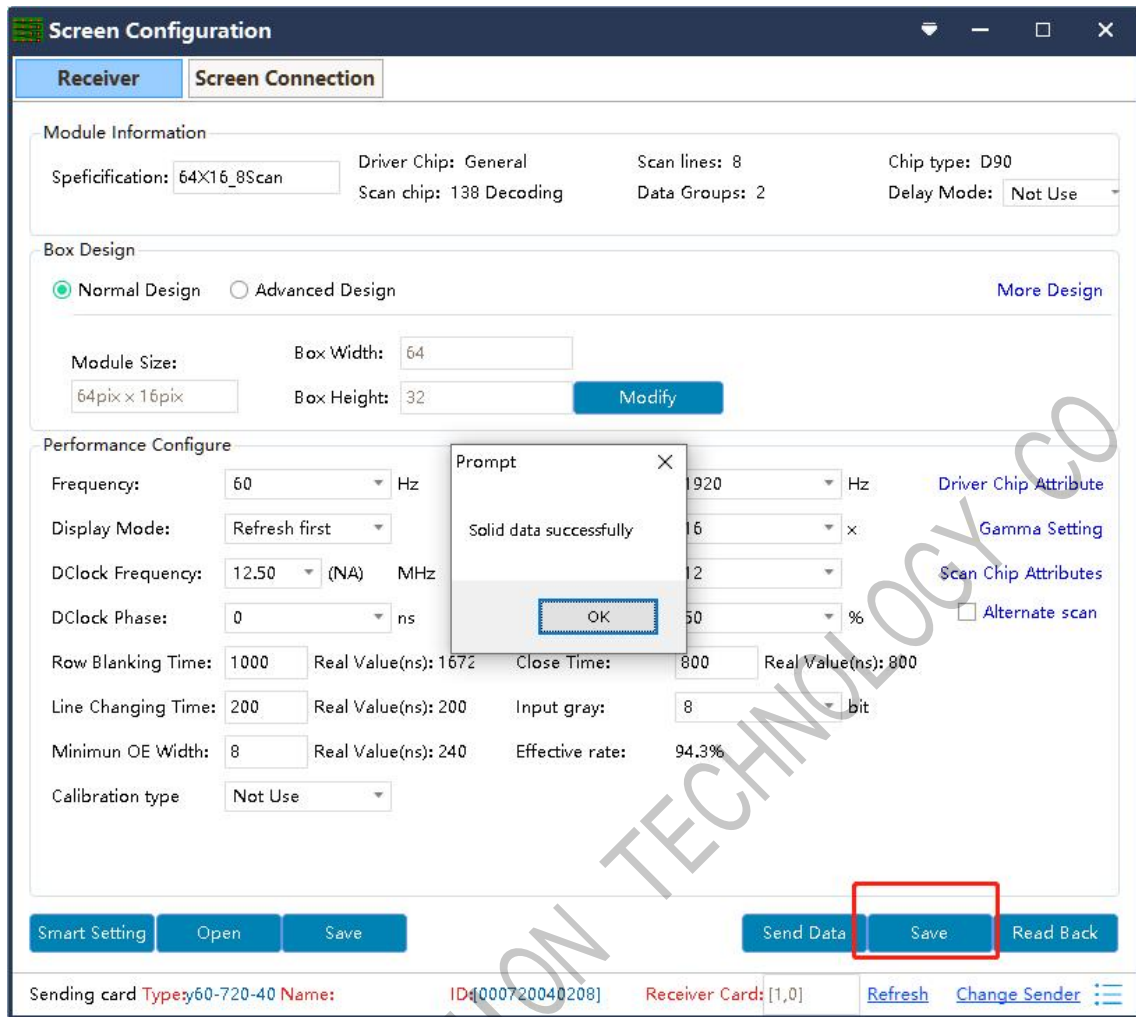

20. Finally click Save Box Config button and save the configuration file to laptop.

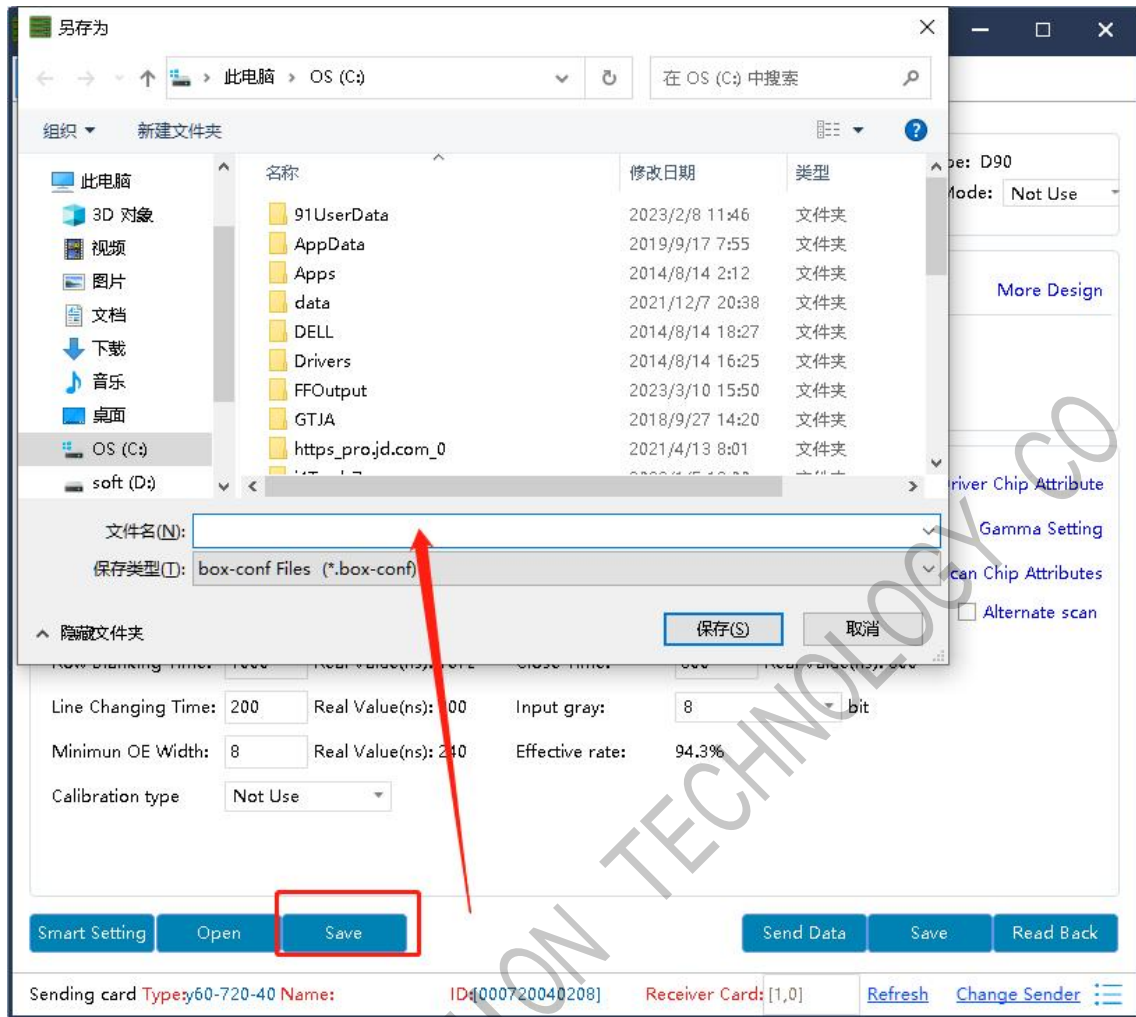

Screen Connection

21. While the receiving card is configured, click the “screen connection” button in the menu bar of the receiving card configuration interface to enter the screen window interface.

① **Load:** load the saved screen configuration file.

② **Save to file:** save the display configuration information to the computer in (*.*) format.

③ **Send:** send screen configuration information to the sending and receiving cards.

④ **Read back:** click this button will read back the existed screen connection configuration from the good working receiving card so that can quickly send to the new receiving card.

⑤ **Open Box sign:** click this button then will auto show the receiving card numbers in correct order in each cabinet.

⑥ **Receiving card quantity:** it will show all receiving cards numbers, there are normally two digits, for example: [1.0] means Ethernet port 1 of sending card has connected 1 receiving card, while Ethernet port 2 of sending card no receiving card.

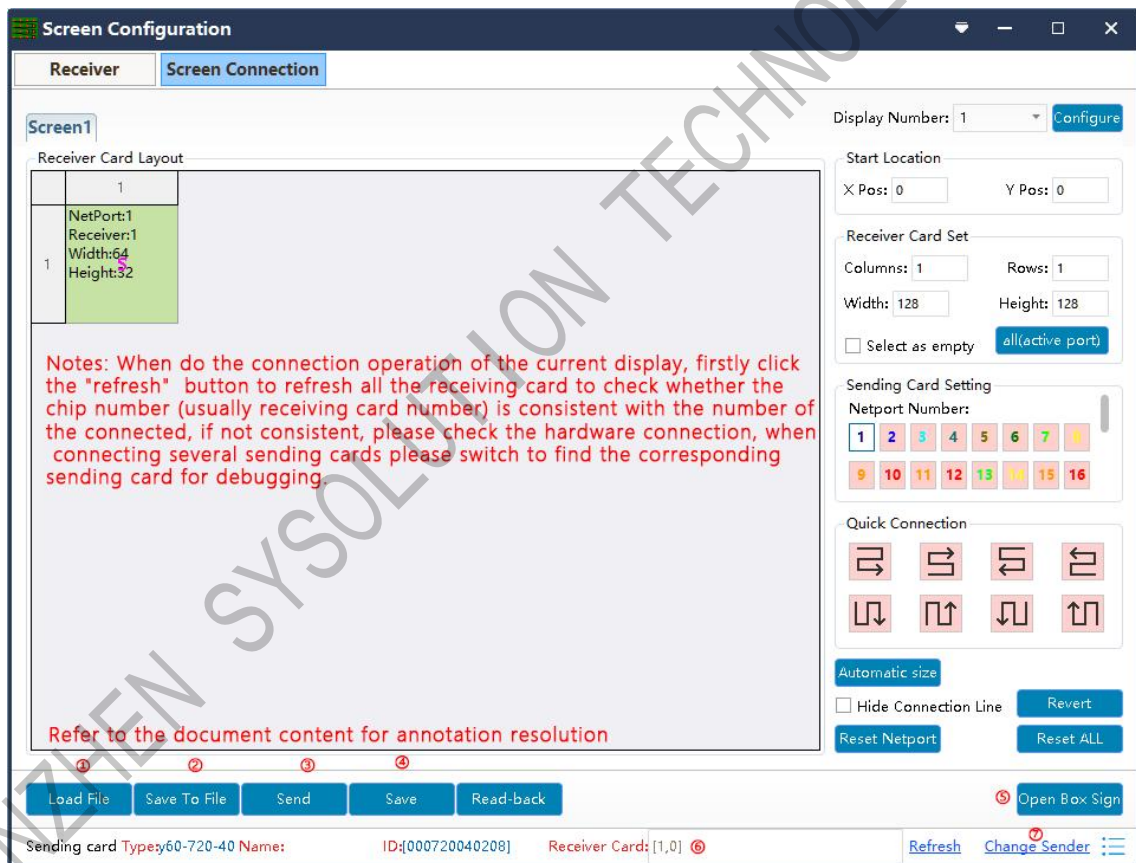

⑦ **Switching sending card:** if there are more than one sending cards in the same network, can switch to the correct sending card when sending parameters.

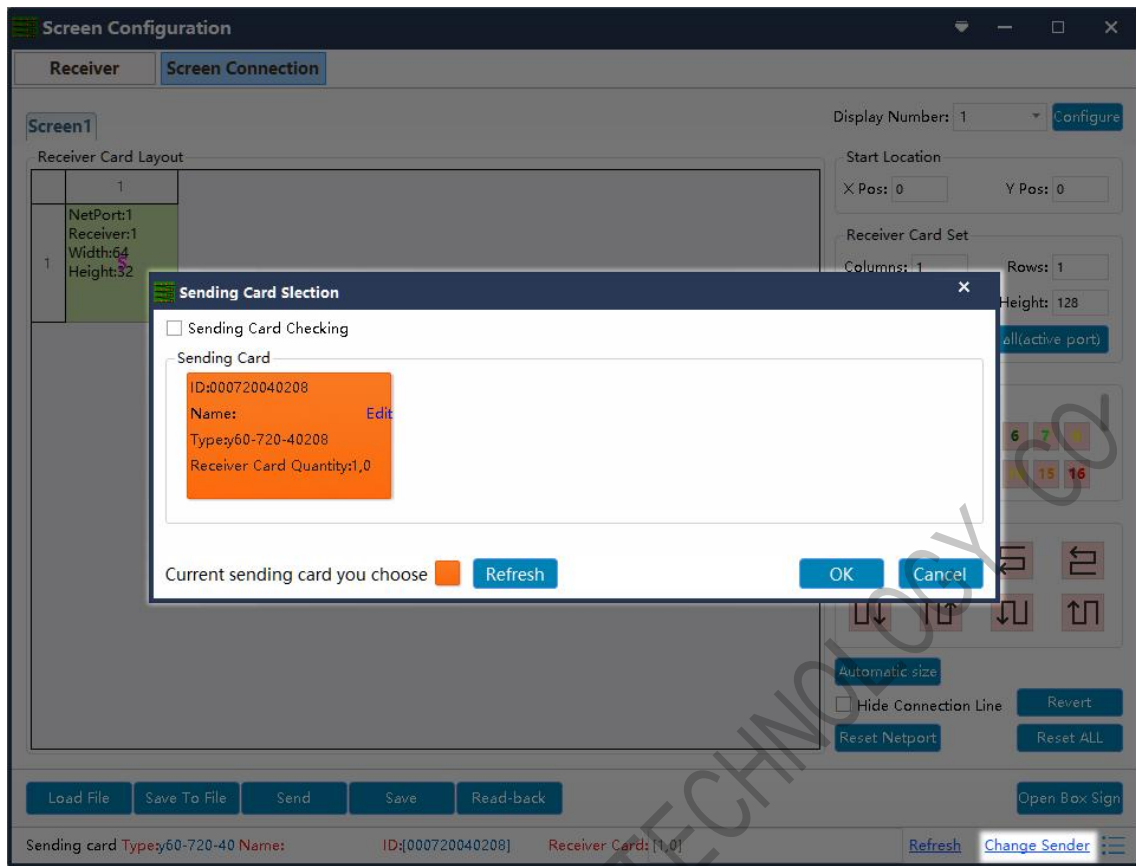

22. In the screen connection interface, the cascade mode of receiving card as well as the width and the height can be set according to the actual situation of large screen, (the width and height of the dots of each receiving cards can be different), Please setup the cascading way including receiver card width and height pixels correctly.

- ① **Display Number:** number range 1-20, please select according to real situation, click Configure button after choose. If choose 2 means LED screen is double sides, you need do screen connection one by one.
- ② **Starting location:** LED display interception position of input signal source. The default state is (0, 0), which means that the LED display starts at the point (0, 0) of the video source.

- ③ **Receiving card Settings:** Set the rows and lines and the dots of the width of each receiving cards according to the actual number of cards used in the screen .
- ④ **Position blank:** click the “Select Empty position” button , and then select the blank. When set, click the button again to exit the select blanks operation.
- ⑤ **Apply to current port :** set the size of all boxes connected to this port to the current column width and column height.
- ⑥ **Sending card setting:** select the output port of sending card.
- ⑦ **Connect hub:** if adopt the hub in the big screen can do following operations:
 - Choose the “Connect HUB” option;
 - Select the sending card Ethernet port and setup the “hub address” ;
 - Choose “hub address” and do screen connection;
- ⑧ **Quick connect:** the entire screen is loaded with only one network cable and the receiving card's network cable is regularly cascaded.
- ⑨ **Hidden connection line:** When checking the hidden connection line box, the display wire knowledge will be hidden.
- ⑩ **Revert:** cancel the lastest operation
- ⑪ **Reset Netport:** will revert all setup for current Ethernet port.
- ⑫ **Revert ALL:** will revert all setup for all network ports.

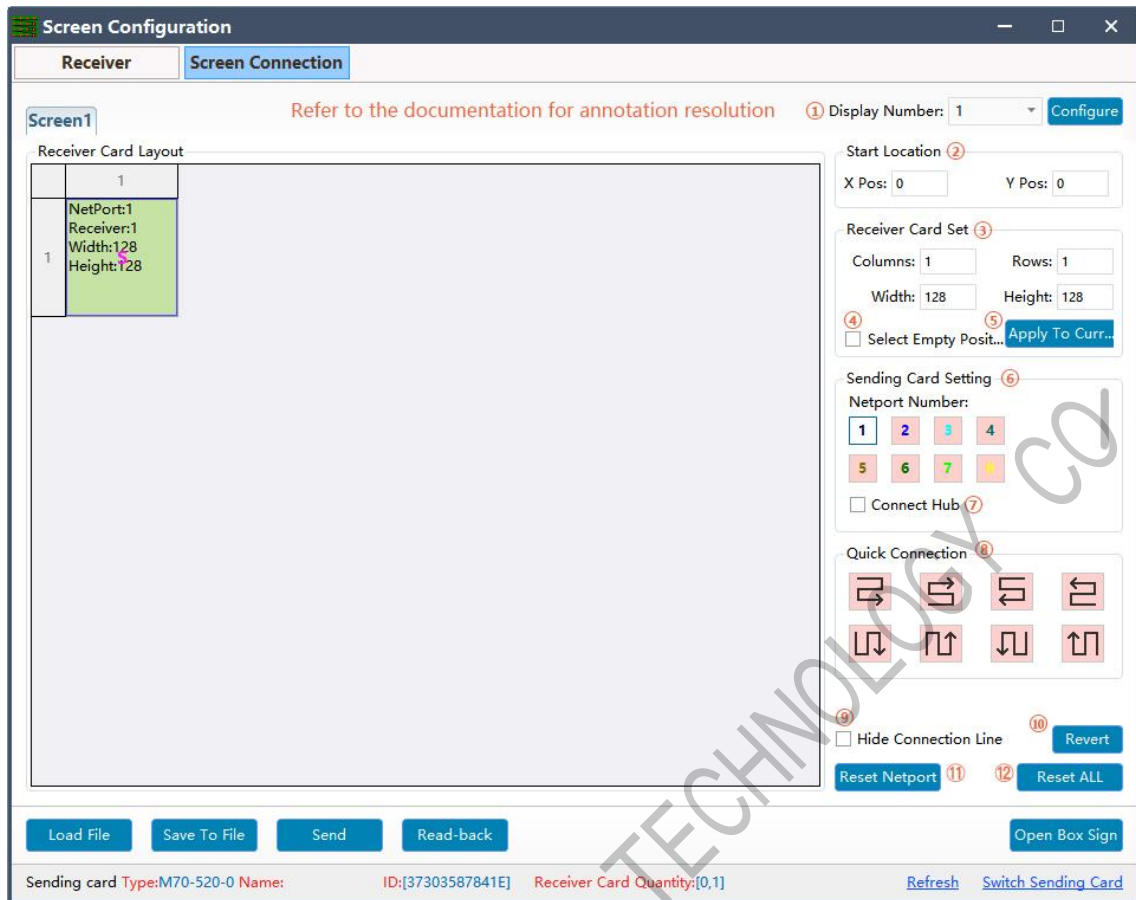

23. Click send and choose “as the main sender” and save to device; or choose “As the backup sender” to save to backup sender device. For double sender backup only work for synchronous controller.

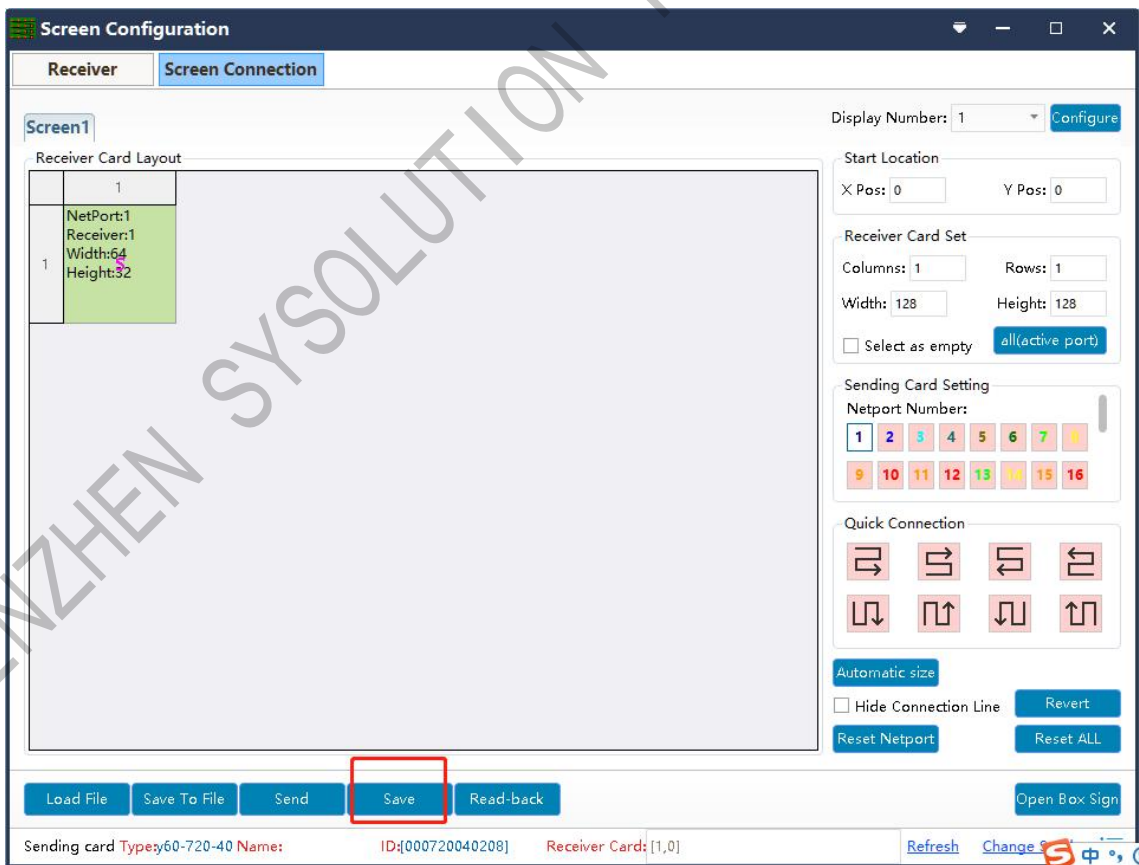
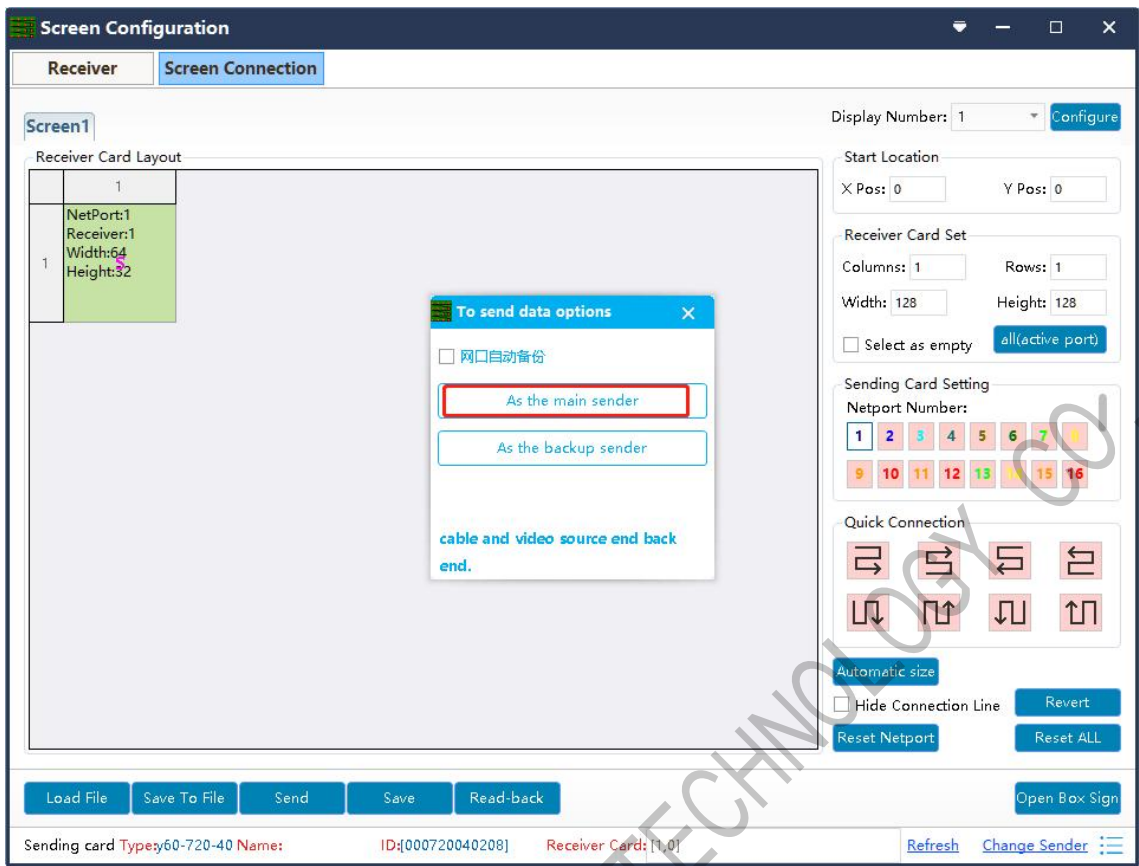

LedOK Setup System Parameters

LED Screen Width And Height Pixels

LedOK Express software, advanced parameters and enter screen width and height pixels, then click save.

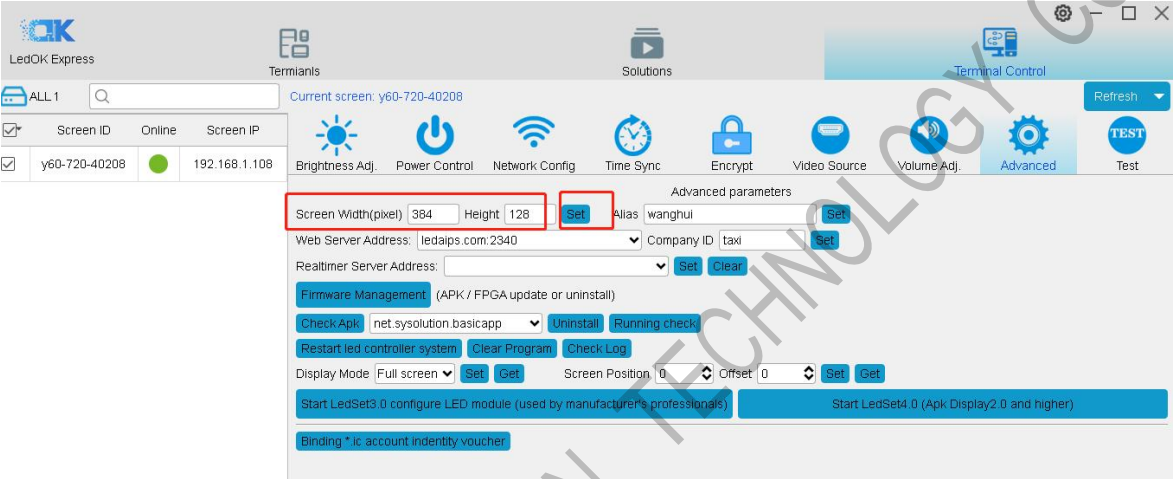

LedOK Setup Network

There are 3 ways of accessing internet for controller, 1. Wire 2. WIFI 3. 3G/4G. can only choose either of them.

Wire Setup

Network configuration, first is Wire, can setup the controller IP address.



NOTES:

1. Controller will get access to internet by wire as first priority.
2. Must remove the LAN cable from controller if choose WIFI or 3G internet and choose automatically acquisition IP.

WiFi Configuration

Turn on WIFI and scanning WIFI hotspot, then enter wifi password and click save.

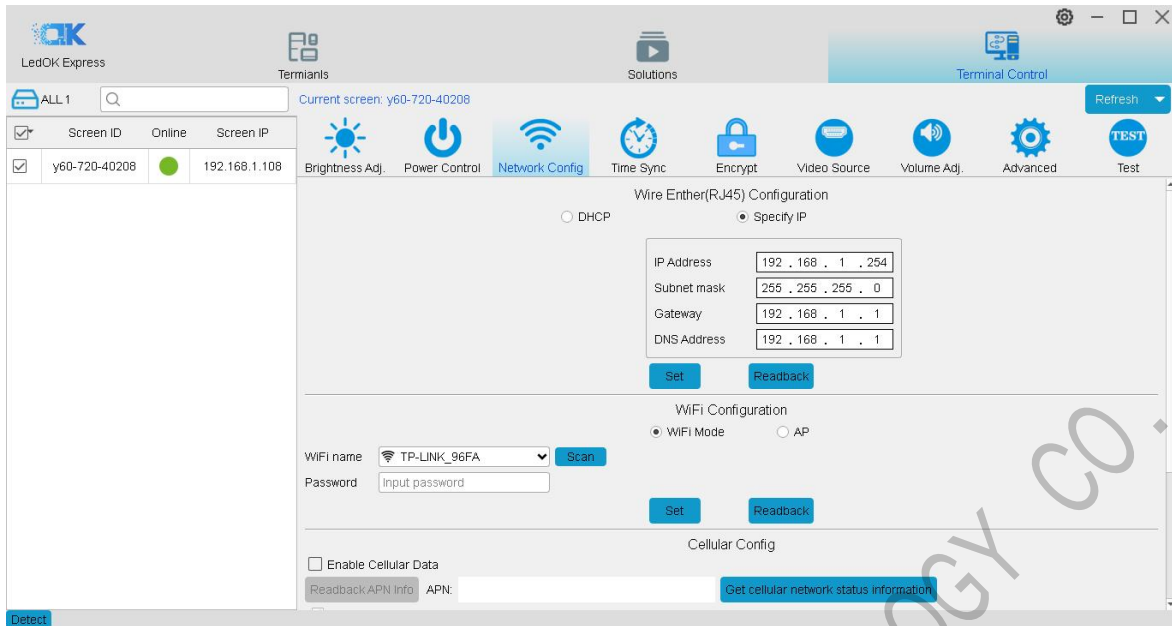

Wait for about 3 minutes, controller will come online. Please watch the “Internet” light, if it flashing regularly means online success, go to AIPS platform and check it.

NOTES:

1. If could not scanning the WiFi, please try to turn on/turn off Software or WiFi Switch.
2. If controller can't get access to internet through WiFi, please double check the steps below:

A.WiFi antenna plug correctly.

B.WiFi password is correct or not.

C.If the Wireless router being accessed too many terminals?

D.E series controller switch on WIFI mode?

E.Try another WIFI hot spot.

F.Y/M series controller, please make sure the LAN cable removed.

3G/4G Setup

Enable 4G/5G option, click "Check" button will auto match the country code MMC and choose the operator name to get the APN, if can not find your country code, please enter by click custom option.



After save 3G parameters, waiting for about 5 minutes, please check if card online in AIPS platform. "Internet" light will flashing fast for dialing up then flashing regularly means get online success.

NOTES:

If controller can't get online success, please checking following things:

A.3G antenna has plugged correctly?

B.Y/M series controller, make sure the LAN cable removed.

C.APN is correct or not?

D.SIM card has activate? SIM card has enough money and 3G data service?

E.Check 3G signal at least 13 and above? Click Network status detection to check 3G signal.

AIPS Cloud Platform Register

Register For AIPS Platform

Visit www.ledaips.com and choose Register to starting input related information, click done and verified the link sent by email, finish the register.

USER LOGIN

LANGUAGE
English

ADMIN ACCOUNT
Admin Account

ADMIN PASSWORD
Admin Password

Login

[Reset password](#) [Join](#)

[Download guide video and documents](#)

SYSOLUTION

We currently recommend the use of Google Chrome for the best experience.
[Click here to download](#)

Oversea address: www.ledaips.com

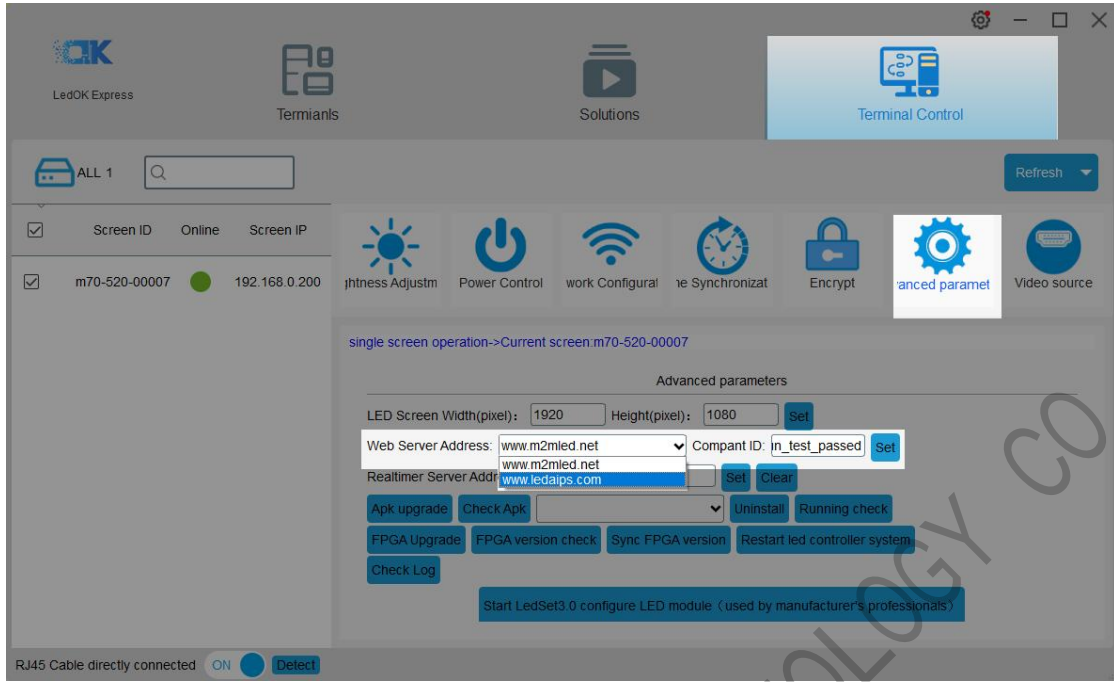

SHENZHEN SYSOLUTION TECHNOLOGY CO., LTD

AIPS Cloud Programming

Simple Program

Make simple program ----only support image or video files

1. Click “add simple program” button and set correct screen width and height pixels and click OK.

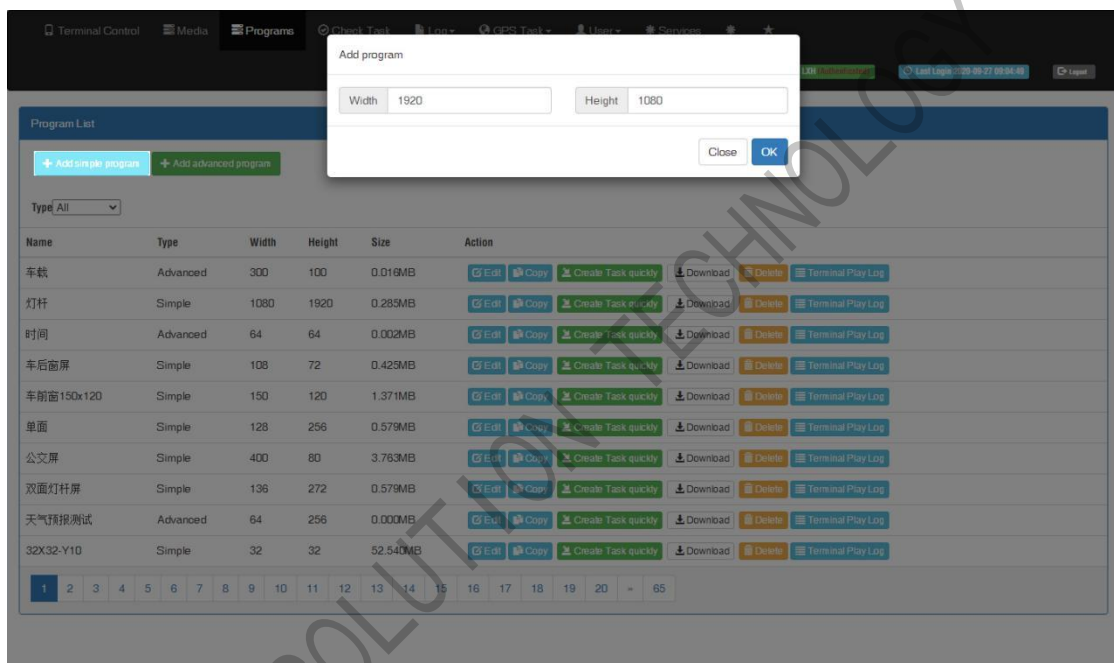

2. Input program name and select the material from left side , here are 3 zones including material in the left side , program editing in the middle and preview window in the right side.

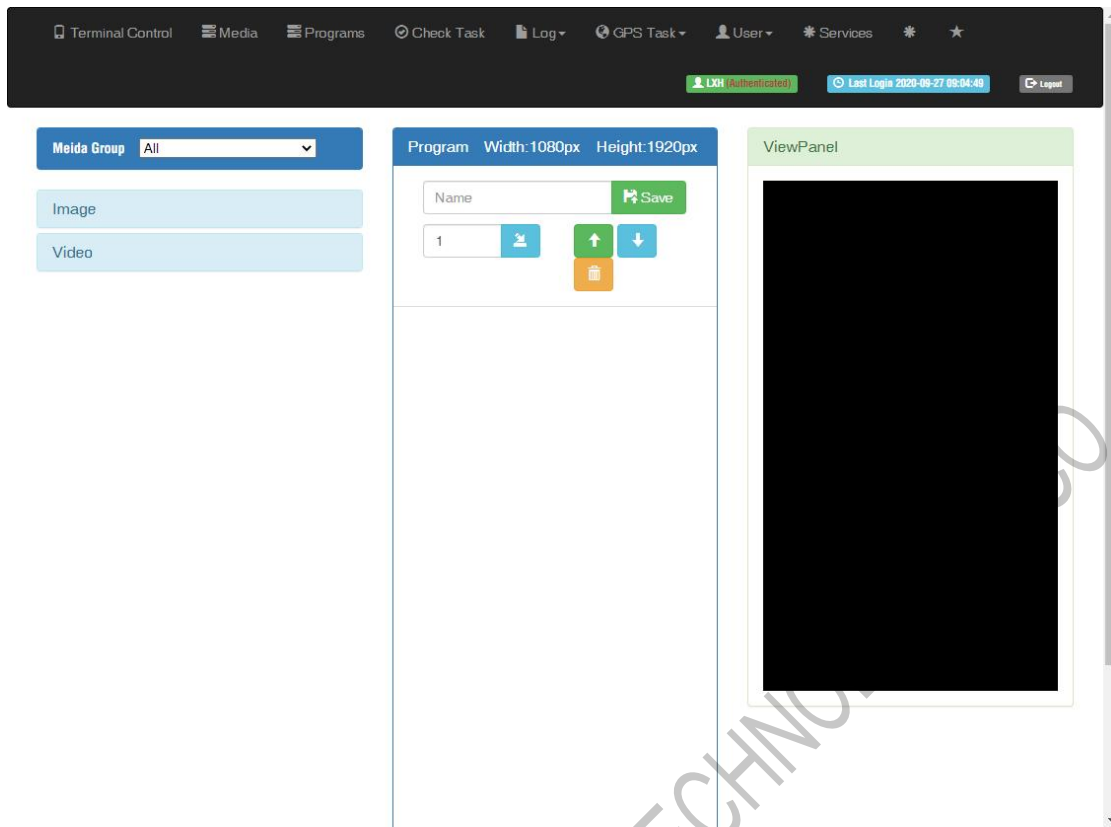

3. Choose materials and set program name, can check preview in the right window.

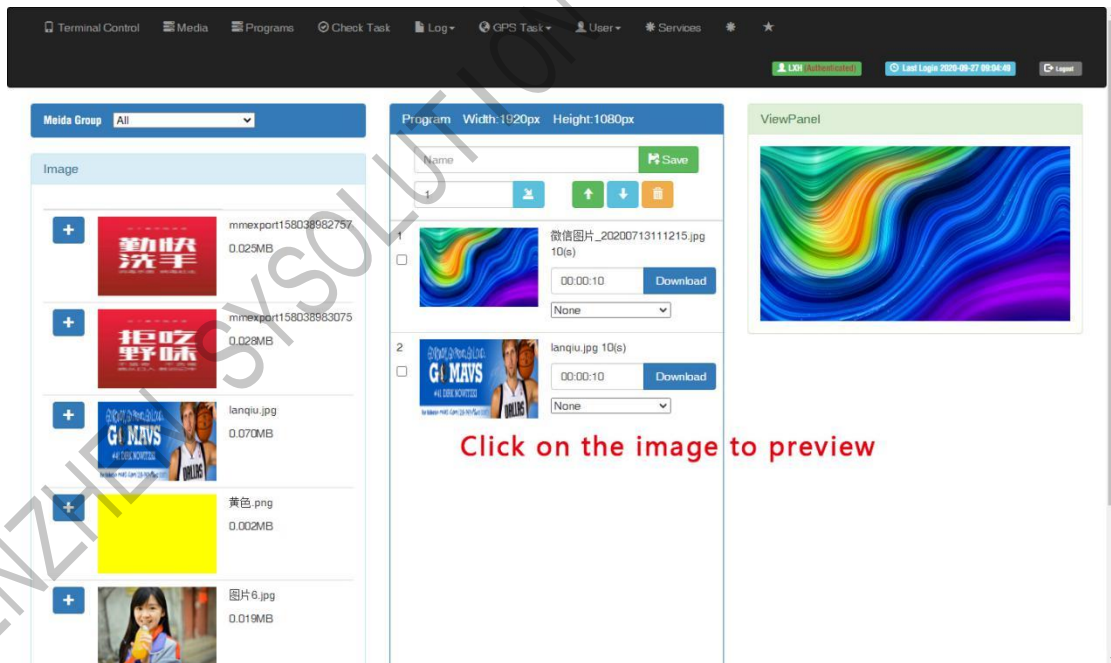

4. Can set the display duration time here, see screenshot in below:

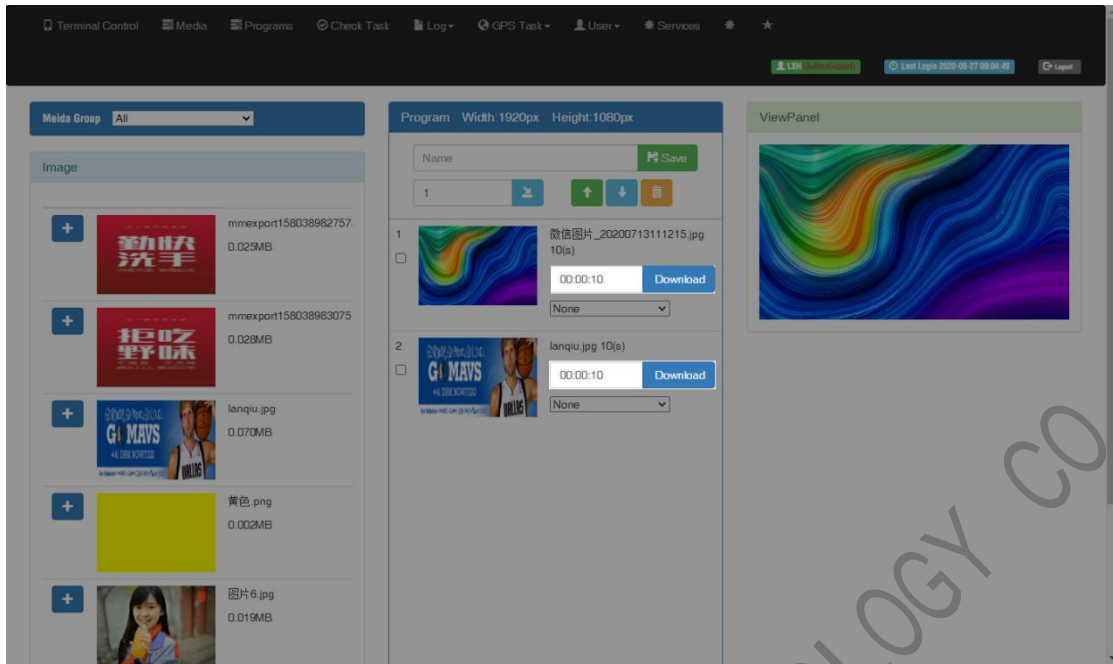

5. Will see program in the list after save.

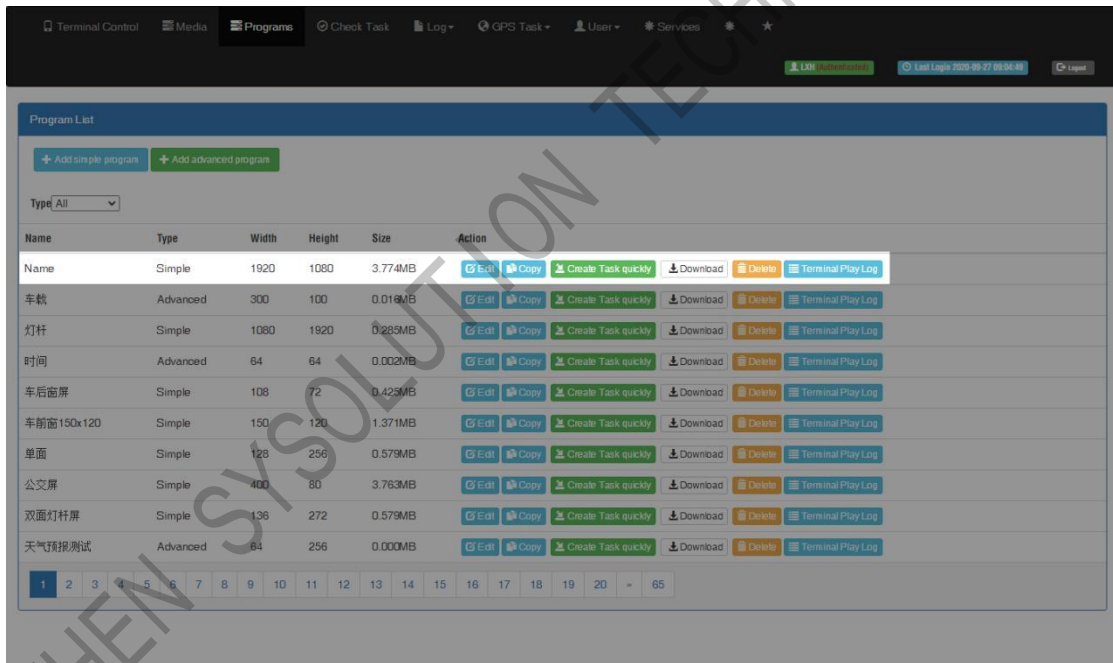

Advanced Program

Advanced program including image, video, clock, text, audio and support more layers.

1. Click "add advanced program" button and set correct screen width and height pixels, click ok.

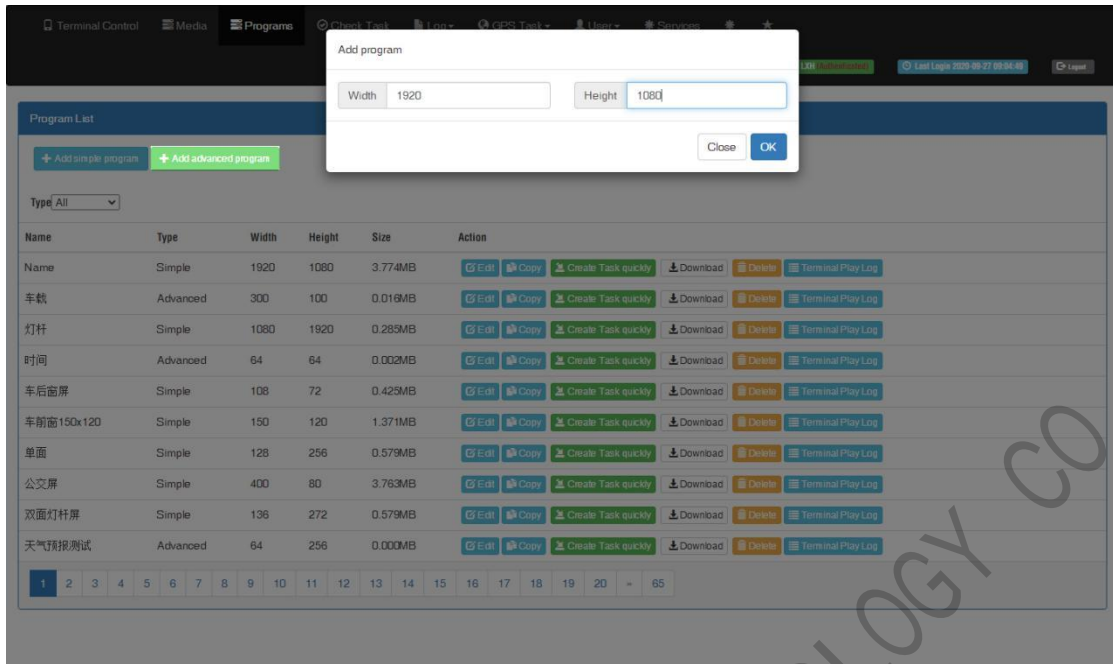

Here are 4 zones including media group, time panel, preview and program property.

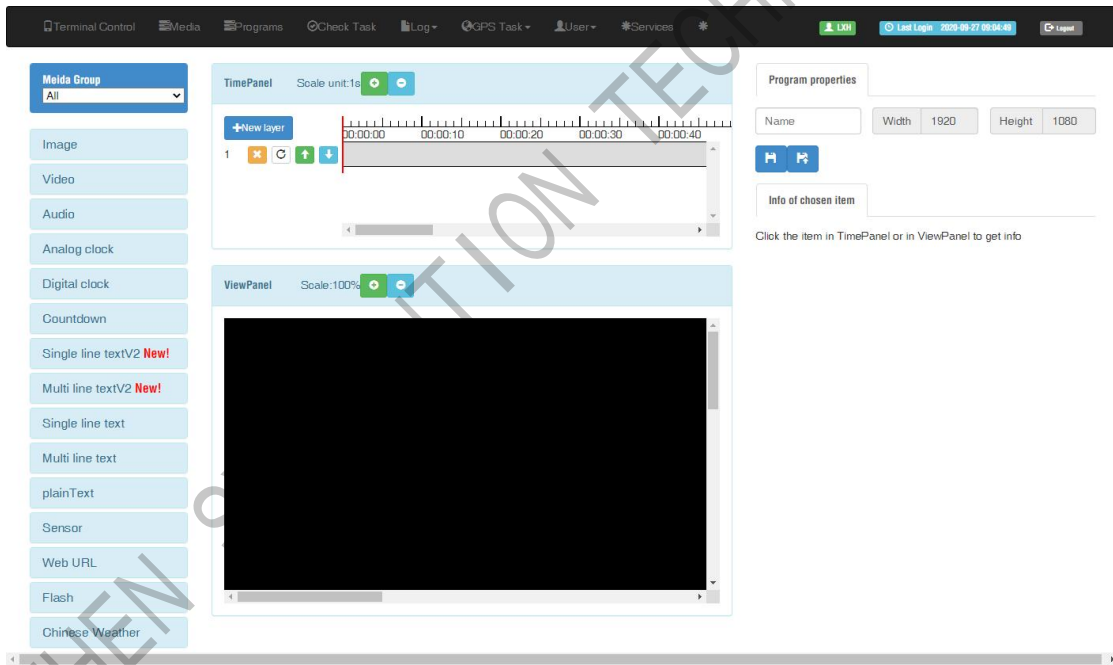

- Click "New layer" button and select media file then add to the time panel, for example: select video file and add to time panel.

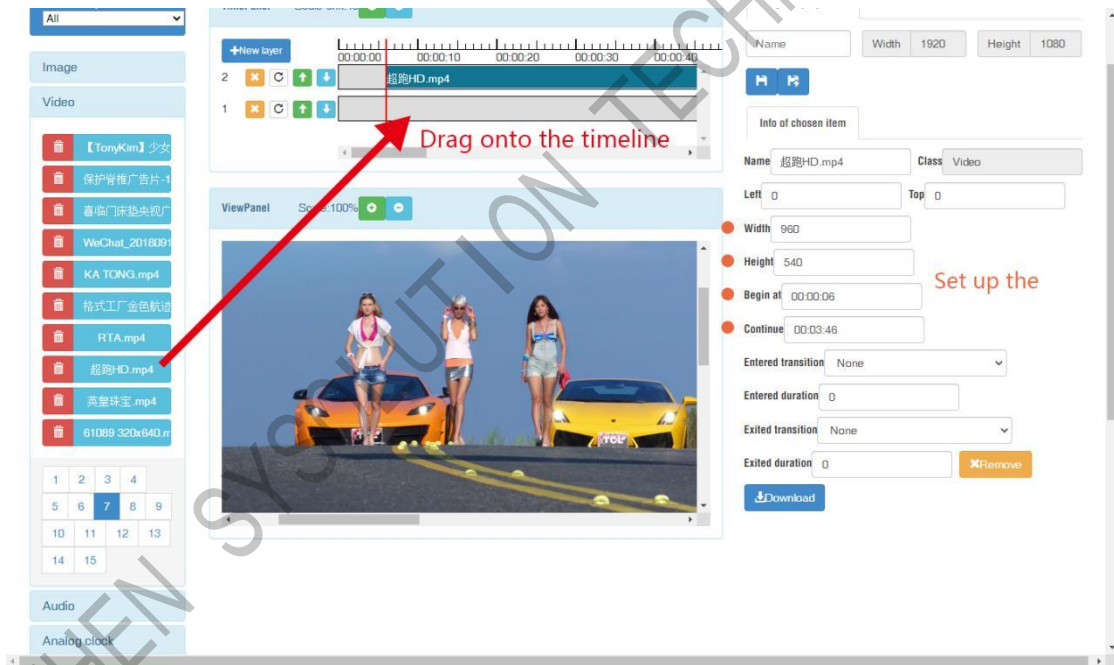
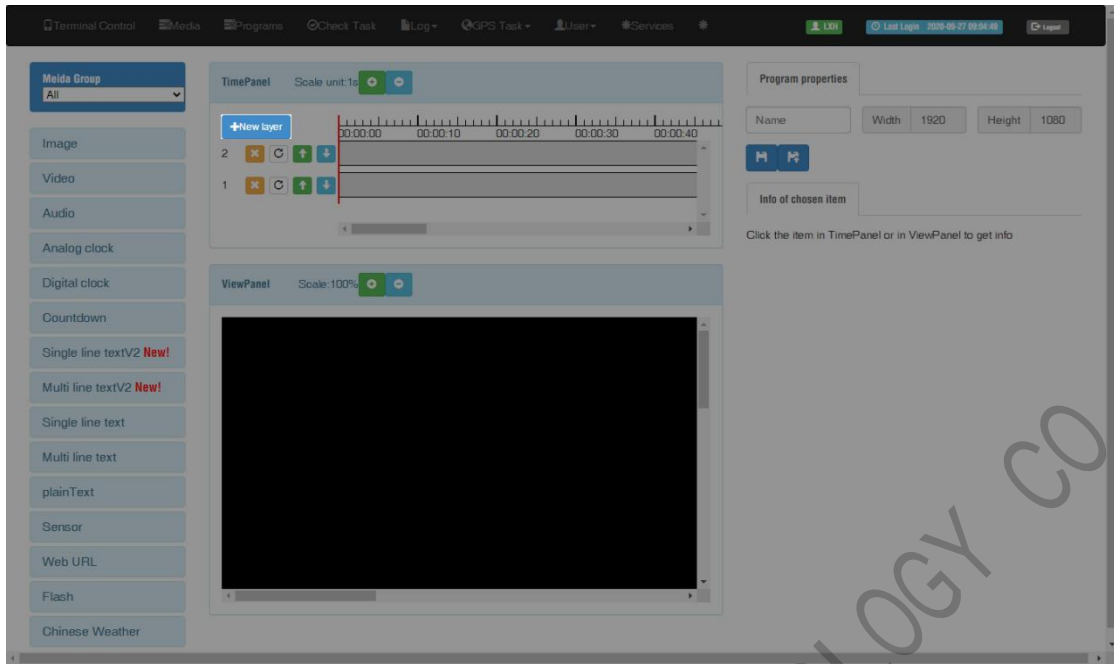

3. Can set the program parameters, start and end time,

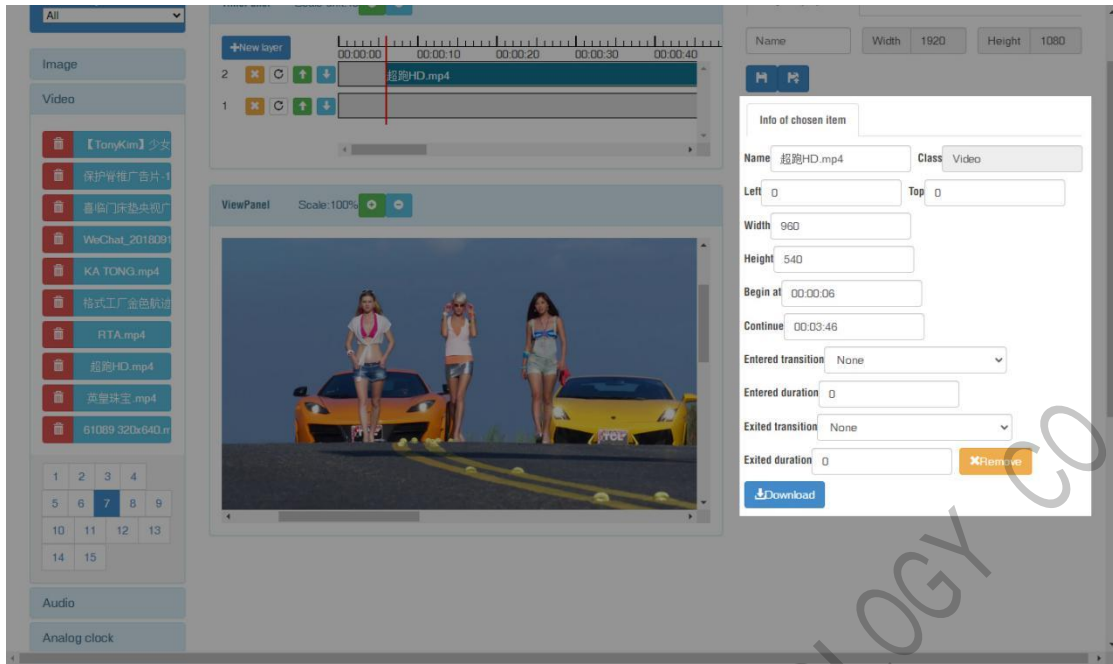

4. Save and quit after setup all parameters and program name.

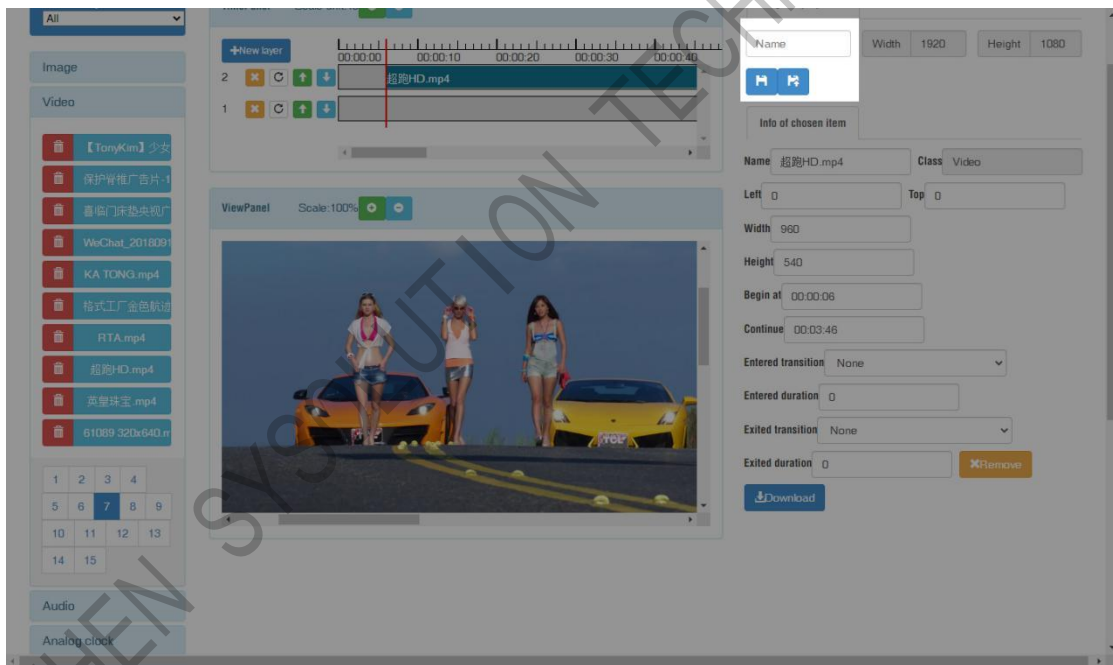

5. Then jump to program list interface, you can click green button of create task quickly and then select controller and send.

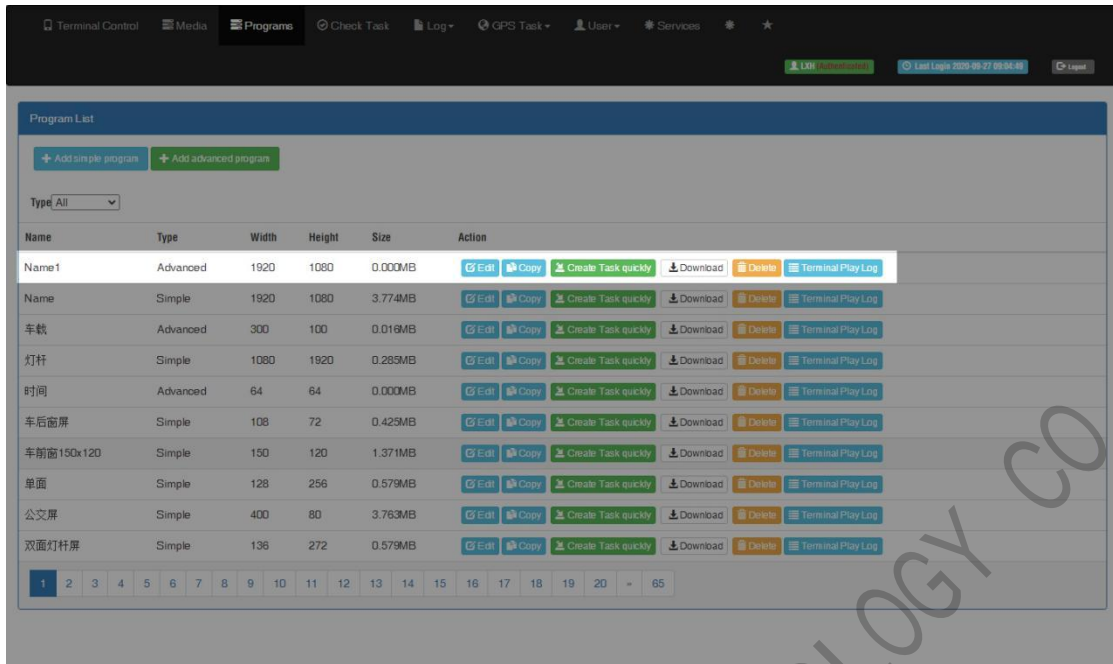

Use the "Edit" button to modify the existing program.

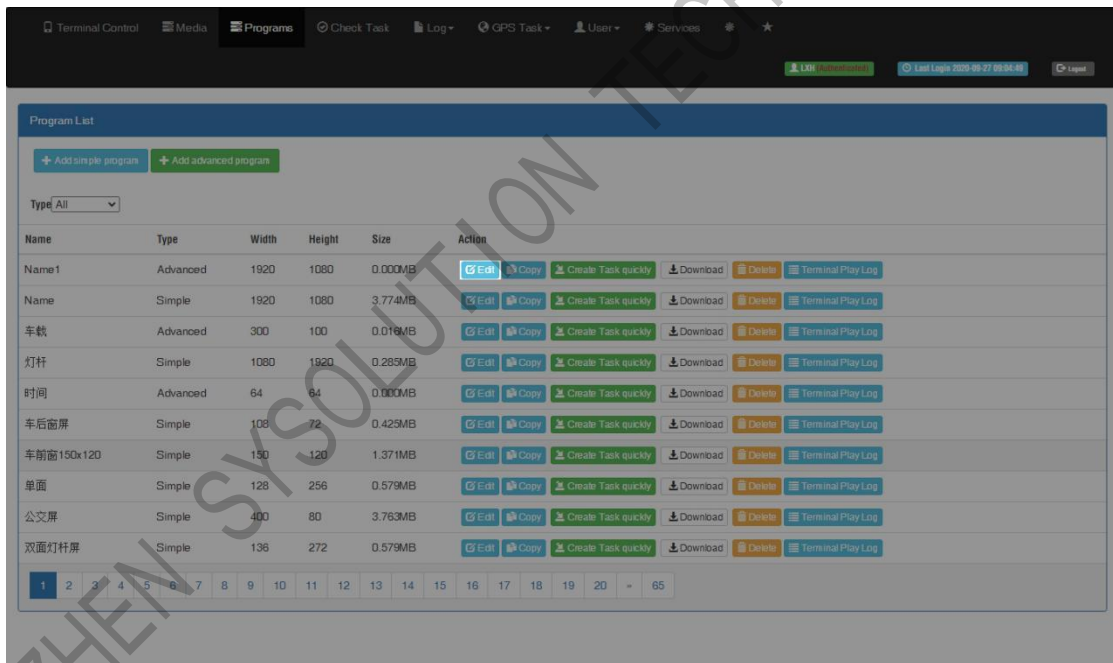

Add multi-line text, click the text (single or multi-text) and add to the time panel

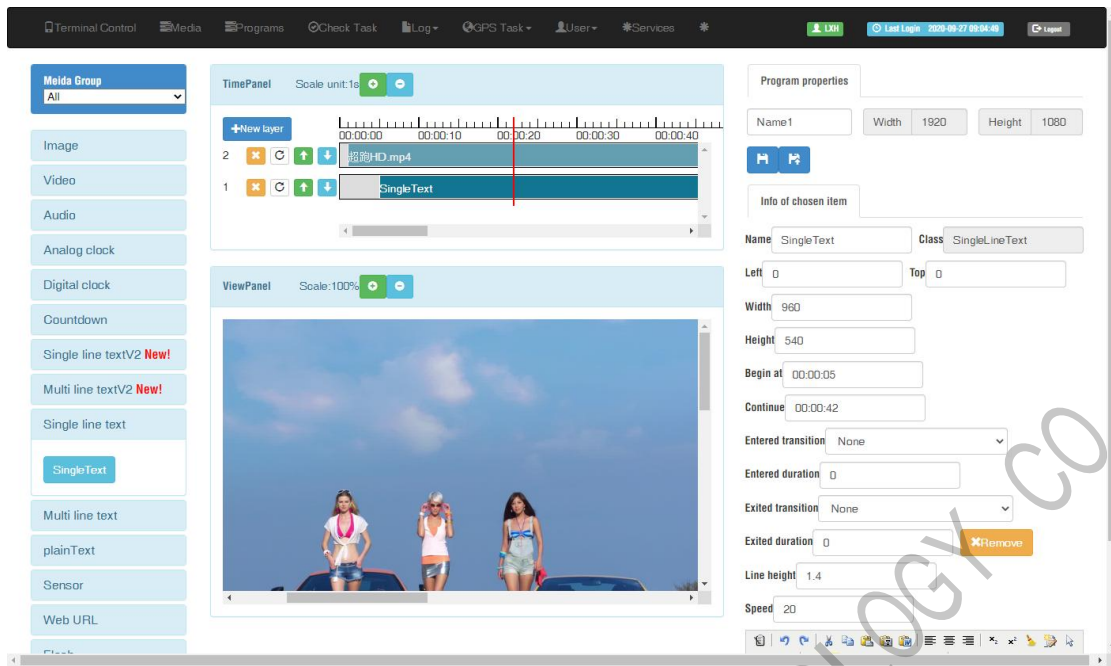

Setup parameters for text, including the start and end time.

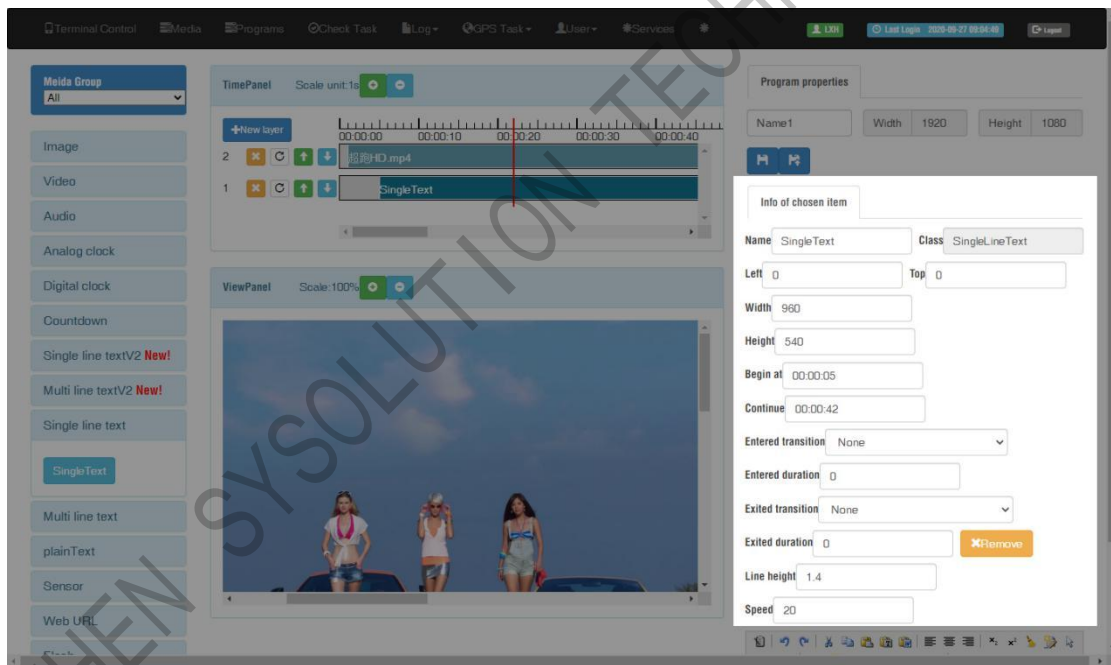

Setup the text color, font size and add more pages, please pay attention to our TIPS message in below, save and quit after finish.



Hint Press Enter to separate next page, Press Shift + Enter to new a line. Define the following string instead of the value of sensors in terminal: %c is celcius, %f is fahrenheit, %h is humidity, (%c1 %f1) or (%c2 %f2) round to 1 or 2 digit(s) after the decimal point

Send Program

1. Click "create task quickly" button in the program list interface and will jump to the terminal interface directly.

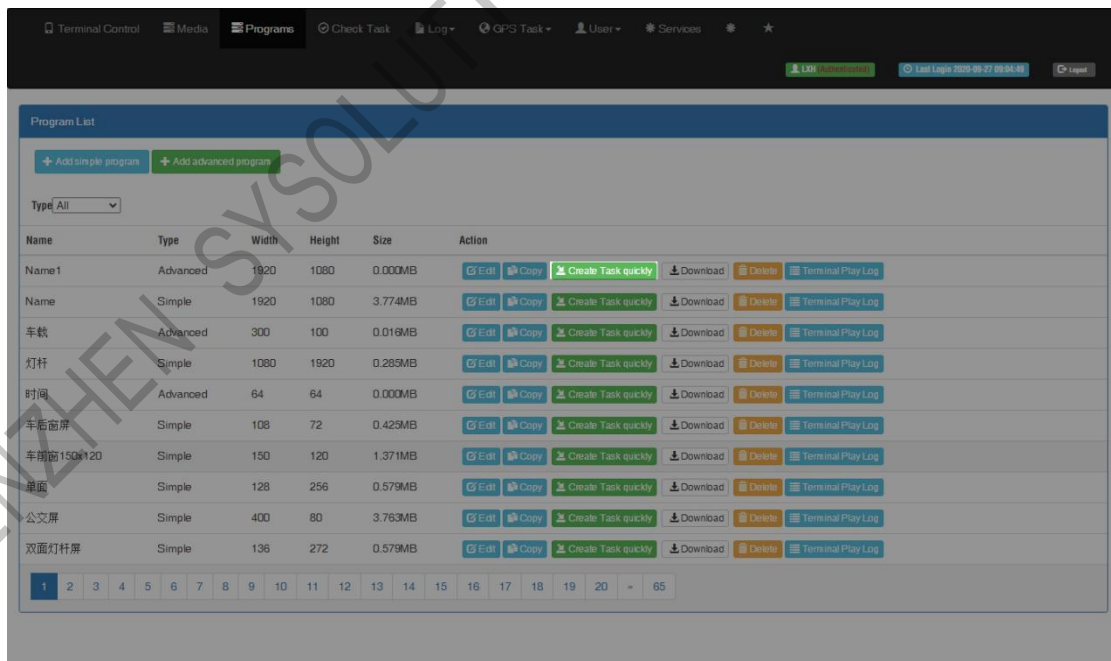

2. Select the controller and send program

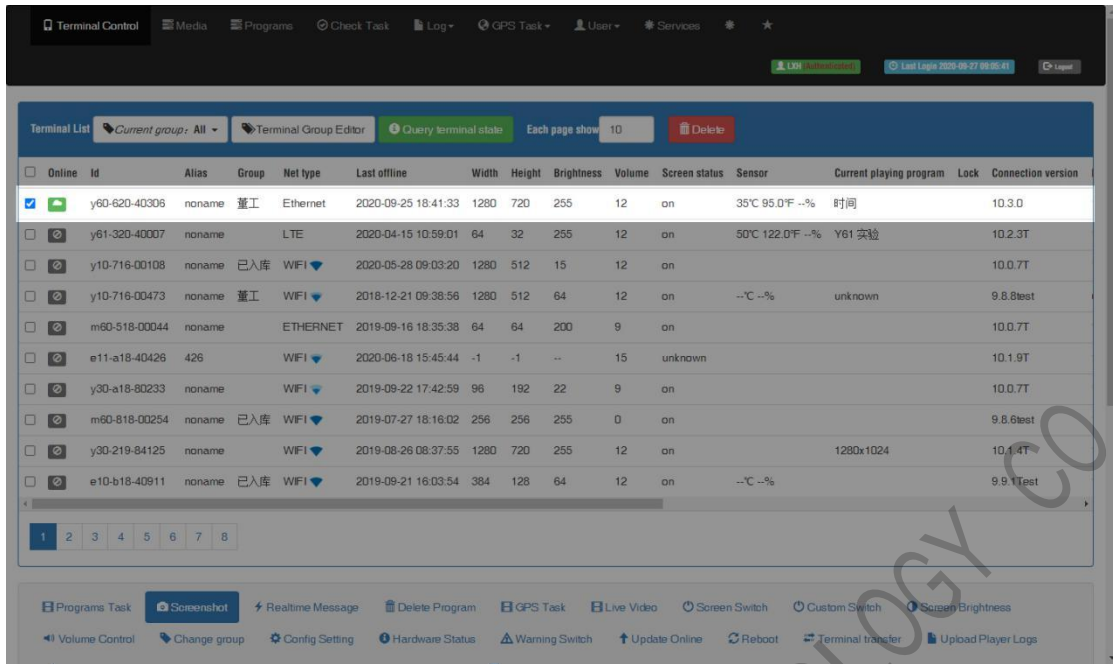

- In the bottom part of terminal interface, will see program task then choose the program task and click send.

